



ANNA VAILANKANNI COLLEGE OF ENGINEERING

(A Christian Minority Institution)

Approved by AICTE, New Delhi & Affiliated to Anna University, Chennai

Recognized under section 2(f) of UGC Act 1956

Website: www.avce.edu.in

AUTHENTICATION CERTIFICATE

This is to certify that the students benefitted by competitive exam and career counseling activities during the assessment years are as follows.

Sl. No	Year	Total No.of Students	No. Of Students Benefitted	Percentage of students Benefitted
1.	2022-2023	538	392	72.8
2.	2021-2022	494	479	96.9
3	2020-2021	435	161	37.0
4	2019-2020	455	356	78
5	2018-2019	526	326	61.8
	AVG			70.1



PRINCIPAL
ANNA VAILANKANNI COLLEGE OF ENGINEERING
POTTALKULAM
AZHAGAPPAPURAM P.O. 629401
KANYAKUMARI DIST.



Address:
AVK Nagar, Pottalkulam,
Azhagappapuram Post, Kanyakumari District - 629401.



Email:
info@avce.edu.in



Phone:
+91-98410 11758
+91-98410 11759
+91-98410 11760



ANNAI VAILANKANNI COLLEGE OF ENGINEERING

(A Christian Minority Institution)

AVK Nagar, Pothaiyadisalai, Pottalkulam, Azhagappapuram Post, Kanyakumari District - 629401

Phone : 04652-266500, 266637 Fax : 04652-266657

Website : www.avce.edu.in e-mail : info@avce.edu.in

Approved by AICTE, New Delhi & Affiliated to Anna University, Chennai.

5.1.3 Percentage of students benefitted by guidance for competitive examinations and career counseling offered by the institution during the last five years.

Academic Year 2018-2019

Sl.No	Academic Year	Name of the activity	Page No
1.	2018-2019	Competitive examinations: Awareness Session on UPSC/TNPSC	1-9
2.	2018-2019	Career Guidance: Personality Development Program	10-14



ANNAI VAILANKANNI COLLEGE OF ENGINEERING

(A Christian Minority Institution)

AVK Nagar, Pothaiyadiselai, Pottalkulam, Azhagappapuram Post, Kanyakumari District - 629401

Phone : 04652-266500, 266637 Fax : 04652-266657

Website : www.avce.edu.in e-mail : info@avce.edu.in

Approved by AICTE, New Delhi & Affiliated to Anna University, Chennai.

5.1.3 Percentage of students benefitted by guidance for competitive examinations and career counseling offered by the institution during the last five years.

Academic Year 2019-2020

Sl.No	Academic Year	Name of the activity	Page No
1.	2019-2020	Competitive examinations: Time Management in Examination	15-23
2.	2019-2020	Career Guidance: Becoming an Entrepreneur	24-28



ANNA VAILANKANNI COLLEGE OF ENGINEERING

(A Christian Minority Institution)

AVK Nagar, Pothaiyadisalai, Pottalkulam, Azhagappapuram Post, Kanyakumari District - 629401

Phone : 04652-266500, 266637 Fax : 04652-266657

Website : www.avce.edu.in e-mail : info@avce.edu.in

Approved by AICTE, New Delhi & Affiliated to Anna University, Chennai.

5.1.3 Percentage of students benefitted by guidance for competitive examinations and career counseling offered by the institution during the last five years.

Academic Year 2020-2021

Sl.No	Academic Year	Name of the activity	Page No
1.	2020-2021	Competitive examinations: Aptitude Training by FACE	29-34
2.	2020-2021	Career Guidance: Aptitude and Soft skill training by Naandhi	35-55



ANNAI VAILANKANNI COLLEGE OF ENGINEERING

(A Christian Minority Institution)

AVK Nagar, Pothaiyadisaalai, Pottalkulam, Azhagappapuram Post, Kanyakumari District - 629401

Phone : 04652-266500, 266637 Fax : 04652-266657

Website : www.avce.edu.in e-mail : info@avce.edu.in

Approved by AICTE, New Delhi & Affiliated to Anna University, Chennai.

5.1.3 Percentage of students benefitted by guidance for competitive examinations and career counseling offered by the institution during the last five years.

Academic Year 2021-2022

Sl.No	Academic Year	Name of the activity	Page No
1.	2021-2022	Competitive examinations: ONE DAY AWARENESS AND QUIZ SESSION ON GATE	56-64
2.	2021-2022	Career Guidance: Placement and Entrepreneurship Opportunities	65-120



ANNAI VAILANKANNI COLLEGE OF ENGINEERING

(A Christian Minority Institution)

AVK Nagar, Pothaiyadisalai, Pottalkulam, Azhagappapuram Post, Kanyakumari District - 629401

Phone : 04652-266500, 266637 Fax : 04652-266657

Website : www.avce.edu.in e-mail : info@avce.edu.in

Approved by AICTE, New Delhi & Affiliated to Anna University, Chennai.

5.1.3 Percentage of students benefitted by guidance for competitive examinations and career counseling offered by the institution during the last five years.

Academic Year 2022-2023

Sl. No	Academic Year	Name of the activity	Page No
1.	2022-2023	Competitive examinations: Career Guidance Program	121-128
2.	2022-2023	Career Guidance: TNSI Awareness Camp	129-153



ANNAI VAILANKANNI COLLEGE OF ENGINEERING

(A Christian Minority Institution)

Approved by AICTE, New Delhi & Affiliated to Anna University, Chennai

Recognized under section 2(f) of UGC Act 1956

Website: www.avce.edu.in

CIRCULAR

11-08-2018

The department of EEE,CSE,CIVIL,MECH and ECE, are jointly organize a program on "UPSC/TNPSC Awareness session" at our college on 13/08/2018 by Mr.C.V.Chenthil, Director, C.V Academy, Nagercoil-01. All students are hereby directed to attend the program positively.

Principal

PRINCIPAL

ANNAI VAILANKANNI COLLEGE OF ENGINEERING

POTTALKULAM

AZHAGAPPAPURAM - 629 401

KANYAKUMARI DIST.

To be read in all classes

Copy to:

The Chairman

The Manager

File



Address:
AVK Nagar, Pottalkulam,
Azhagappapuram Post, Kanyakumari District - 629401.



Email:
info@avce.edu.in



Phone:
+91-98410 11758
+91-98410 11759
+91-98410 11760



ANNAI VAILANKANNI COLLEGE OF ENGINEERING
(Approved by AICTE, New Delhi & Affiliated to Anna University, Chennai)
AVK Nagar,, Pottalkualm, Azhagappapuram P.O.Kanyakumari District-629 401
EVENT REPORT

Name of the programme/Activity: "UPSC/TNPSC Awareness session"	
Date: 13/08/2018	Time : 10 a.m -12 p.m
Venue Conference Hall	Total participants: 250
Name of the Resource Person: Mr.C.V.Chenthil,	Designation: Director,C.V Academy, Nagercoil-01
Report: The department of EEE,CSE,CIVIL,MECH and ECE, are jointly organize a program on "UPSC/TNPSC Awareness session" at our college on 13/08/2018 by Mr.C.V.Chenthil, Director, C.V Academy, Nagercoil-01.He explained the use of UPSC /TNPSC exam. It serves as a corner stone of India's civil service recruitment system, playing a vital role in shaping the nation administrative structure and promoting good governance	

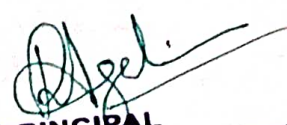

PRINCIPAL
ANNAI VAILANKANNI COLLEGE OF ENGINEERING
POTTALKULAM
AZHAGAPPAPURAM - 629 401
KANYAKUMARI DIST.



ANNAI VAILANKANNI COLLEGE OF ENGINEERING
(Approved by AICTE, New Delhi & Affiliated to Anna University, Chennai)
AVK Nagar, Pottalkulam, Azhagappapuram P.O. Kanyakumari District-629 401

NAME LIST

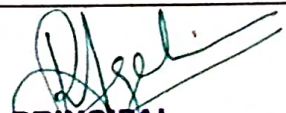
1.	960115103001	C.Elavarasan
2.	960115103002	J.Jobin
3.	960115103003	D.R.Monisha
4.	960115103004	K.Ramkumar
5.	960115103005	M.K.Ramya
6.	960115103301	A.Abinesh
7.	960115103701	Manivarma.M
8.	960115104002	DHURGA S
9.	960115104004	MANJU S
10.	960115104005	NISHA M
11.	960115104006	PABITHA M
12.	960115104007	PRATHISHA B
13.	960115104008	RAJENDRA ASHMI R V
14.	960115104009	RESHMA RAJAN
15.	960115104010	SAHAYA RASHIMA V
16.	960115104011	SATNI GEORGE PREMI J
17.	960115104012	SHERIN PRIYA DHARSHINI K
18.	960115104013	SOWMYA R
19.	960115104014	VIMAL DHAS S
20.	960115104301	RESHMA.R
21.	960115106001	Bhuvanshwari R
22.	960115106002	Granaf Mini a
23.	960115106003	Jancy Rani J
24.	960115106004	Meena kamali K
25.	960115106005	Princy Christal j
26.	960115106006	vanalakshmi p
27.	960115106008	Vinisha V
28.	960115106501	Rexin Geo R
29.	960115106301	Manikandan A
30.	960115106302	Vivek bright W
31.	960115105001	Ajesh R C
32.	960115105002	Linto J
33.	960115105003	Prabhu S
34.	960115105004	Sajin G
35.	960115105005	Selva K
36.	960115105006	Soosai Vimal M
37.	960115105301	Gnana Belwin I
38.	960115105302	Lingeswaran N
39.	960115114001	AJIESH RAJA R
40.	960115114002	AJITH P
41.	960115114003	AJITHLANGO P
42.	960115114004	ANBARASAN R
43.	960115114005	ANTONY SELVA RIYO M
44.	960115114006	ANTONY VINITH JIJIN A
45.	960115114007	ARULRAJ S
46.	960115114008	ARUN RAJ S
47.	960115114009	BALAJI S
48.	960115114010	CHALS WESLEY M
49.	960115114011	DINESH R

PRINCIPAL
ANNAI VAILANKANNI COLLEGE OF ENGINEERING
POTTALKULAM
AZHAGAPPAPURAM - 629 401
KANYAKUMARI DIST.

50.	960115114013	JEYAGANESH K
51.	960115114014	JOBIN R J
52.	960115114015	LIJIN ASSISI P
53.	960115114016	MANIKANDAN M
54.	960115114017	MANOJ B
55.	960115114018	MARSHELABISHEAK I J
56.	960115114019	MAYANDI S
57.	960115114020	MICHAEL PRADEEP J
58.	960115114021	MOORTHY V
59.	960115114022	NAVEEN KUMAR P
60.	960115114023	PRASANTH R
61.	960115114024	PRATHEESH S
62.	960115114025	PRAVIN N
63.	960115114026	RAMESHKUMAR M
64.	960115114027	RANJITH KUMAR
65.	960115114029	SELVA MURUGAN T
66.	960115114030	SIVA V
67.	960115114031	SUBASAMY M
68.	960115114032	SUDALAI RAJ P
69.	960115114033	SUJIN S
70.	960115114034	SURESH M
71.	960115114035	SUYAMBULINGAM A
72.	960115114036	THANISH RAJA R
73.	960115114037	THILAIKAN J
74.	960115114038	THIYAGU T
75.	960115114039	THOMSON E
76.	960115114040	UDAYASEKAR S
77.	960115114041	VIGNESH N
78.	960116103002	AKHIL S
79.	960116103003	AKSHY J
80.	960116103009	BRUCE JEBA STARVIN D
81.	960116103015	DINESH M
82.	960116103017	JINO
83.	960116103018	KALAI NILAN S U
84.	960116103022	MRITY ANJAY KUMAR
85.	960116103023	NISHANANTHINI S
86.	960116103025	PINASHA M
87.	960116103029	SAHANA VINDHYA P
88.	960116103033	VINOTHA J
89.	960116103302	MUNIYARAJ V
90.	960116103303	SIVA SANKARI M
91.	960116103304	VIDHYA JYOTHI S P
92.	960116104001	ABISHA BARM
93.	960116104005	ANTANY NIMITHA S
94.	960116104006	ARUN BENNY
95.	960116104008	ASWITHA T
96.	960116104011	DIVYA M
97.	960116104012	FEMIL SHANI
98.	960116104015	JEEVAN JEDLY G
99.	960116104016	MEKALA DEVI
100.	960116104018	PAVITHRA A
101.	960116104022	REENA
102.	960116104024	SAHAYA JESSE MONISHA
103.	960116104025	SANGEETHA E
104.	960116104027	SHYJU R
105.	960116104029	THARANYA M
106.	960116106002	AMUTHA R

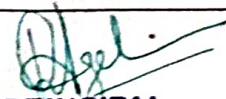

PRINCIPAL
ANNAI VAILANKANNI COLLEGE OF ENGINEERING
POTTALIKULAM
 AZHAR ... 99 401
 KANTHAKANNI DIST

107.	960116106003	ANTO ANI SULBIYA N
108.	960116106009	DEVADHARSHINI R
109.	960116106011	PRIYA K
110.	960116106015	SONIA SUBASH
111.	960116106016	SUJATHA G
112.	960116106017	REXIN GEO R
113.	960116105003	Elayaraja
114.	960116105301	Kannan S
115.	960116105302	Rajakumar S
116.	960116105303	Selvakumar S
117.	960116114001	ABSARIN K N
118.	960116114002	AJITH V
119.	960116114004	ANISH G
120.	960116114005	ARUL M
121.	960116114006	ARUN R V
122.	960116114007	ASHOK KUMAR M
123.	960116114008	ASWINI R V
124.	960116114009	BALA MURUGAN E
125.	960116114010	BALA SUBRAMANIAN A
126.	960116114014	CHINNA DURAI K
127.	960116114015	GANESH RAJ S
128.	960116114016	HARI BABU R
129.	960116114017	HARIHARAN O
130.	960116114018	INBA KUMAR E
131.	960116114019	LAKSHMANAN
132.	960116114020	MAGESH M
133.	960116114024	MARI SELVAM S
134.	960116114025	MATHI RAJ M
135.	960116114027	MELGIN RICH
136.	960116114029	MURUGESH R
137.	960116114030	PARTHIBAN H
138.	960116114031	PRADEEPKUMAR A
139.	960116114032	PRASANTH I
140.	960116114033	PRATHAP S
141.	960116114034	PRIYA DARSHINI M
142.	960116114036	RAHUL P
143.	960116114037	RAJESH M
144.	960116114038	RAMKUMAR R
145.	960116114039	RICHARD NOVA Y
146.	960116114040	Rohit Kumar
147.	960116114041	SABARISH A
148.	960116114042	SAHAYA KIRAN
149.	960116114043	SAMUEL J
150.	960116114045	SARATH M
151.	960116114047	SATHA SIVAM M
152.	960117104001	ABISHA NEYA I
153.	960117104002	AJITHRA S
154.	960117104004	AMIRTHAM P
155.	960117104005	ANANDA ARASU T
156.	960117104006	ANGELIN MARY G
157.	960117104007	ANJELIN THARSHINI A
158.	960117104008	ANJU P
159.	960117104009	ANUSUYA A
160.	960117104011	ASHTALAKSHMI M
161.	960117104012	GOKUL VISWANTH
162.	960117104016	JENISHA R J
163.	960117104018	JUBIN JOSEPH MATHEW



PRINCIPAL
ANNAI VAILANKANNI COLLEGE OF ENGINEERING
POTTALKULAM
AZHAGAPPAPURAM - 629 401
KANYAKUMARI DIST.

164.	960117104021	MAHESWARI M
165.	960117104022	MAKESHWARI B
166.	960117104023	MAMTHA V
167.	960117104024	MICHEAL JASMINE SINDHIYA E
168.	960117104025	MUKESH S
169.	960117104026	MUTHU MANISHA M
170.	960117104028	RAJA LAKSHMI M
171.	960117104029	RAJANI CHRISH S
172.	960117104030	REVATHI P
173.	960117104031	ROHINI N
174.	960117104032	SAHAYA JENIBHA Y
175.	960117104033	SAHAYA KALAI SELVI B
176.	960117104034	SAJIN C L
177.	960117104035	SANTHINI K
178.	960117104036	SATHISH KUMAR D
179.	960117104037	SATHYA M
180.	960117104038	SENAGA S
181.	960117104039	SHERLIN BENCY B
182.	960117104040	SINDHU V
183.	960117104041	SIVA P
184.	960117104042	SNEKA S
185.	960117104043	SOBANA E
186.	960117104044	SREEJITH R S
187.	960117104045	SUBHA KANI S
188.	960117104046	SUNITHA T
189.	960117106001	ABARNA A F
190.	960117106002	ABILASH LAWRANCE L
191.	960117106003	AJEESHA S
192.	960117106004	ANISHA M
193.	960117106005	ANTONY MILLINOR P
194.	960117106006	ASWINI SHIYANA M
195.	960117106007	BEENU J B
196.	960117106008	BEMELINE BLENCY LAL S L
197.	960117106010	ISWARYA R
198.	960117106011	JASMIN PRINCY J
199.	960117106012	JENISH J
200.	960117106013	MAHALEKSHMI M
201.	960117106014	MONISHA R B
202.	960117106015	MUPPIDATHI C
203.	960117106016	MUTHUMARI P
204.	960117106020	NAVARENJINI G V
205.	960117106021	NITHESH NETHAJI D
206.	960117106022	PAVITHRA A
207.	960117106023	PREETHAROSE R
208.	960117106024	PRINCY A
209.	960117106025	PUSHPA LATHA T
210.	960117106027	RESHMA S R
211.	960117106028	SEEVALAPERIYA M
212.	960117106029	SHEEJA S
213.	960117106030	SHERIN S V
214.	960117106031	SIVA PRAKASH V
215.	960117106032	SUMITHRA S
216.	960117106316	SAHAYA NIVETHA
217.	960117105001	Ajith R
218.	960117105002	Arumugam T
219.	960117105003	Franklin Mano S
220.	960117105004	Jenisha S

PRINCIPAL
ANNAI VAILANKANNI COLLEGE OF ENGINEERING
POTTALKULAM
AZHAGAPPAPURAM - 629 401
KANYAKUMARI DIST.

221.	960117105005	Periyasamy C
222.	960117105006	Ramalingam S
223.	960117105007	Sathish S
224.	960117105008	Subash M
225.	960117105009	Vicknesh S
226.	960117105310	JINI STERLIN S M
227.	960117105313	RAJEESRAJA J(Long Absent)
228.	960117105315	SATHEESH N
229.	960117114001	ABINESH R
230.	960117114003	ABIRAM A
231.	960117114004	AJAY RAJAN R
232.	960117114007	ANANDHU UNNIKRISHINAN
233.	960117114008	ANISII THOMSON M
234.	960117114009	ANTONY JEROME J
235.	960117114010	ANTONY VINIS J
236.	960117114011	ANTO RABY R
237.	960117114012	ARUNKUMAR M
238.	960117114013	ASWIN A
239.	960117114014	BALA VIGNESH S
240.	960117114015	CINU C
241.	960117114016	CLINTON J
242.	960117114017	DHARUMADURAI S
243.	960117114018	ERAMIYA C
244.	960117114019	FRANKLIN M
245.	960117114020	GNANA MOORTHY P
246.	960117114021	GOKUL P R
247.	960117114022	IVIN R
248.	960117114023	JENISH G R
249.	960117114024	JENISH L
250.	960117114039	PRASHANTH P

PRINCIPAL
ANNAI VAILANKANNI COLLEGE OF ENGINEERING
POTTALKULAM
AZHAGAPPAURAM - 629 401
KANNIYAKUMARI DIST.

CAREER COUNSELLING



ANNAI VAILANKANNI COLLEGE OF ENGINEERING

(Approved by AICTE, New Delhi & Affiliated to Anna University, Chennai)

AVK Nagar, Pottalkulam, Azhagappapuram P.O. Kanyakumari District-629 401

EVENT REPORT

Career Guidance and Personality development program

DATE: 25/08/2018

VENUE: BOSCH LAB

The department of Computer Science & Engineering organized a guest lecture for the students of CSE and ECE. The guest speaker was **Mr. Michael Packiyaraj**, Sr Associate L2 (Tech Lead) Sapient Technologies, Bangalore. He has around 10 years of industry experience. He delivered a lecture on Career Guidance and personality development.

The lecture covered the areas including personality development, interview skills and current trends in IT. In personality development he explained the students how to be bold, patient, curious and honest. All the qualities were explained with real time examples. While talking about interview skills he started from very basic of preparing a resume. He asked the students to research the industry and company to know more about the field and current updates. The students were given idea on what to talk in interview and what not to talk. He insisted the students to reply only for the questions asked by the interviewer. He explained the students how to behave and convince the people. He explained the importance of attitude.

The current trends in the IT field were discussed. He asked the students to develop them self in the current technological areas like web front end development, Mobile web application, cloud computing, Agile technology, Mobile applications and data analytics.

PRINCIPAL
ANNAI VAILANKANNI COLLEGE OF ENGINEERING
POTTALKULAM
AZHAGAPPAPURAM - 629 401
KANYAKUMARI DIST.

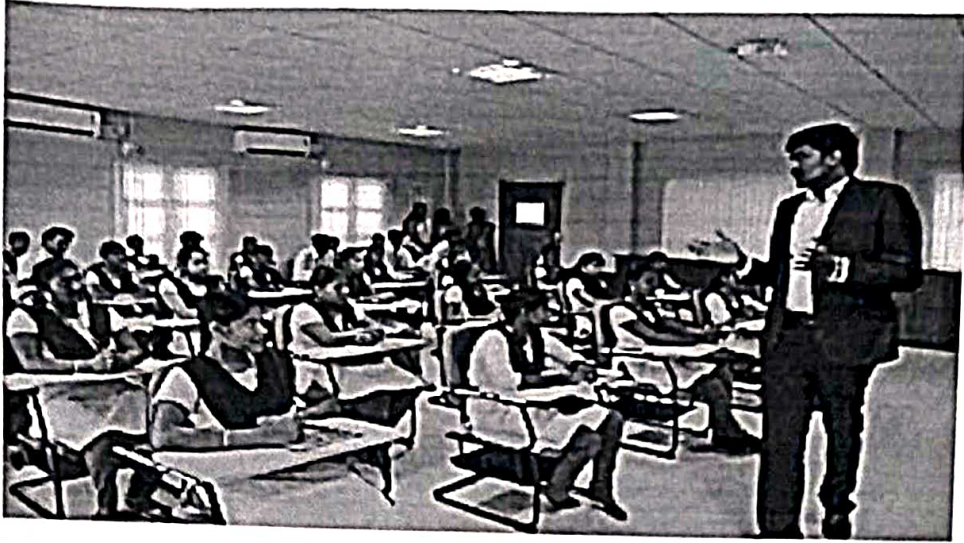

He asked the students to discover their passion and never give up in their dreams. The session was very interesting and interactive with real life examples. The students got a clear idea in interview skills, personality development and current trends. He appreciated the students in their technological ideas and asked the students to overcome their inferiority complex to come forward to express their ideas and grab the available golden opportunities. The department of Computer Science & Engineering extends their warm and heartfelt thanks to Mr. A. Raja Winston, AP, AVCE for making the event possible.

PRINCIPAL
ANNAI VAILANKANNI COLLEGE OF ENGINEERING
POTTALKULAM
AZHAGAPPAPURAM - 623 401
KANYAKUMARI DIST.



ANNAI VAILANKANNI COLLEGE OF ENGINEERING

(Approved by AICTE, New Delhi & Affiliated to Anna University, Chennai)

AVK Nagar, Pottalkulam, Azhagappapuram P.O. Kanyakumari District - 629 401

Sl.No	Name	Branch
1	ABINESHR	CIVIL
2	ANNIESTEPHILA	CIVIL
3	ESAKKIMUTHU C	CIVIL
4	EZHILROSHIKA S	CIVIL
5	HARISHRK	CIVIL
6	JEBINT	CIVIL
7	KALAISELVANM	CIVIL
8	KARTHIKAB	CIVIL
9	MERLINGRACEC	CIVIL
10	MUTHUSIVASUBRAMANIANM	CIVIL
11	PONNAZAGUMONISHAP	CIVIL
12	SRINATHO	CIVIL
13	SUNIL S	CIVIL
14	SURESHRAJAS	CIVIL
15	ABISHAMOLJ	CSE
16	ABITHA N	CSE
17	ANTONYMICHEALS	CSE
18	AROCKIADIVYAA	CSE
19	ASIBA. A	CSE
20	BALAMURUGAN M	CSE
21	DEVA.R	CSE
22	DEVI S	CSE
23	DINESHM	CSE
24	EMIMALS	CSE
25	ESAKKISABARISHVARANS	CSE
26	ESAKKI DEVI B	CSE
27	GODWIND	CSE
28	JANANI B	CSE
29	JEBARESHMAJ	CSE
30	JEBINL	CSE
31	JEEVITHAD	CSE
32	KAUSALYAV	CSE
33	MALLIKA.S	CSE
34	MANJUM	CSE
35	MARIYA A	CSE
36	MASANAMALATHI.D	CSE
37	MICHEALFRANCISKISHORE. A	CSE
38	MURUGAMMALR	CSE
39	MUTHUBHARATHIM	CSE
40	MUTHUKANNANS	CSE
41	MUTHUKUMART	CSE
42	NISHAA	CSE
43	PRIYAT	CSE
44	RAKESH A	CSE
45	RAMA SWAMY.R	CSE
46	SABARISHAS	CSE
47	SELVASUTHAA	CSE
48	SHIBIN.S	CSE

PRINCIPAL
ANNAI VAILANKANNI COLLEGE OF ENGINEERING
POTTALKULAM
AZHAGAPPAPURAM - 629 401
KANYAKUMARI DIST.

49	SINTHUJAA	CSE
50	SIVASUBATHAK	CSE
51	SUBHASHINI C	CSE
52	DELMAROSE	CSE
53	AKILAR	ECE
54	AROCKIASTANLINPRAKASH	ECE
55	BIBISHA.M	ECE
56	INBAMUKILA	ECE
57	INDUMATHIB	ECE
58	JENSI.Y	ECE
59	MASANAME	ECE
60	NITHYAM	ECE
61	PAVITHRAM	ECE
62	RAMALAKSHMI	ECE
63	SANJAYKUMAR	ECE
64	SULAEBHA. M	ECE
65	SUMITHAR	ECE
66	SUBATHRAS	ECE
67	Ajith S	EEE
68	Arun PJ	EEE
69	DineshV	EEE
70	DivyaJothiP	EEE
71	JinsJebaDhasS	EEE
72	Muthubharathi	EEE
73	SenthiR	EEE
74	Sujith M	EEE
75	Ajith M	EEE
76	Arunkumar S	EEE

PRINCIPAL
ANNAI VAILANKANNI COLLEGE OF ENGINEERING
POTTALKULAM
AZHAGAPPAPURAM - 629 401
KANYAKUMARI DIST.

COMPETITIVE EXAMINATIONS



ANNA VAILANKANNI COLLEGE OF ENGINEERING

(A Christian Minority Institution)

Approved by AICTE, New Delhi & Affiliated to Anna University, Chennai

Recognized under section 2(f) of UGC Act 1956

Website: www.avce.edu.in

25-11-2019

CIRCULAR

The department of EEE,CSE,CIVIL,MECH and ECE, are jointly organize a program on "TIME MANAGEMENT IN EXAMINATION" at our college on 26/11/2019 by ECC Academy, Nagercoil-01. All students are hereby directed to attend the program positively.

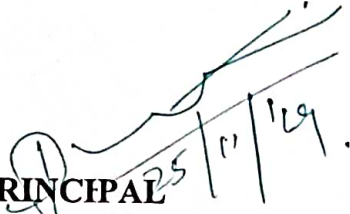
PRINCIPAL
PRINCIPAL
ANNA VAILANKANNI COLLEGE OF ENGINEERING
POTTALKULAM
AZHAGAPPAPURAM - 629 401
KANYAKUMARI DIST.

To be read in all classes

Copy to:

The Chairman

The Manager

File



Address:
AVK Nagar, Pottalkulam,
Azhagappapuram Post, Kanyakumari District - 629401.



Email:
info@avce.edu.in



Phone:
+91-98410 11758
+91-98410 11759
+91-98410 11760



ANNAI VAILANKANNI COLLEGE OF ENGINEERING
(Approved by AICTE, New Delhi & Affiliated to Anna University, Chennai)
AVK Nagar,, Pottalkulam, Azhagappapuram P.O. Kanyakumari District-629 401
Event Report

Name of the programme/Activity: Time Management in Examination"	
Date:: : 26/11/2019	Time : 10a.m -12 p.m
Venue :Conference Hall	Total participants:235
ECC ACADEMY	

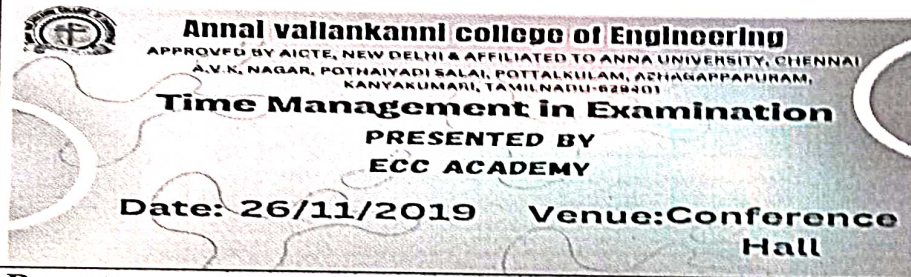

Report:

The department of EEE,CSE,CIVIL,MECH and ECE, are jointly organize a program on "Time Management in Examination" at our college on 26/11/2019 by ECC Academy, Nagercoil-01.He explained how to manage the time while writing the exam and also he explained the short cut way of problem solving .

NAME LIST

1.	ABISHA BARM
2.	ANTANY NIMITHA S
3.	ARUN BENNY
4.	ASWITHA T
5.	DIVYA M
6.	FEMIL SHANI
7.	JEEVAN JEDLY G
8.	MEKALA DEVI
9.	PAVITHRA A
10.	REENA

PRINCIPAL
ANNAI VAILANKANNI COLLEGE OF ENGINEERING
POTTALKULAM
AZHAGAPPAPURAM - 629 401
KANYAKUMARI DIST.

11.	SAHAYA JESSE MONISHA
12.	SANGEETHA E
13.	SHYJU R
14.	THARANYA M
15.	AMUTHA R
16.	ANTO ANI SULBIYA N
17.	DEVADHARSHINI R
18.	PRIYA K
19.	SONIA SUBASH
20.	SUJATHA G
21.	REXIN GEO R
22.	Elayaraja
23.	Kannan S
24.	Rajakumar S
25.	Selvakumar S
26.	ABSARIN K N
27.	AJITH V
28.	ANISH G
29.	ARUL M
30.	ARUN R V
31.	ASHOK KUMAR M
32.	ASWINI R V
33.	BALA MURUGAN E
34.	BALA SUBRAMANIAN A
35.	CHINNA DURAI K
36.	GANESH RAJ S
37.	HARI BABU R
38.	HARIHARAN O
39.	INBA KUMAR E
40.	LAKSHMANAN
41.	MAGESH M
42.	MARI SELVAM S
43.	MATHI RAJ M
44.	MELGIN RICH
45.	MURUGESH R
46.	PARTHIBAN H
47.	PRADEEPKUMAR A
48.	PRASANTH I
49.	PRATHAP S
50.	PRIYA DARSHINI M
51.	RAHUL P
52.	RAJESH M
53.	RAMKUMAR R
54.	RICHARD NOVA Y
55.	Rohit Kumar
56.	SABARISH A
57.	SAHAYA KIRAN
58.	SAMUEL J
59.	SARATH M

PRINCIPAL
ANNAI VAILANKANNI COLLEGE OF ENGINEERING
POTTALKULAM
AZHAGAPPAPURAM - 629 401
KANYAKUMARI DIST.

60.	SATHA SIVAM M
61.	SEENIVASADURAI
62.	ANOOF M
63.	ANTONY NIVIN A
64.	ANTO VINISH S
65.	ARUN PRAKASH S
66.	ARUN PRAVIN M P
67.	DINO SNOWS VALAN DAS M
68.	MAHARAJAN A
69.	MESWIN MARIA JENITH N
70.	AJITHA S
71.	ANITHA K
72.	BIBIN S
73.	GAYATHRI C
74.	INDHUMATHI K
75.	JANEESH D R
76.	MAREESWARI T
77.	MARY STEPHY C
78.	MONISHA S
79.	NISHA S
80.	PANDI RAJATHI G
81.	RANJITH A
82.	REJISHA T
83.	SAHAYA RENISHA G
84.	SAHIN S
85.	THANASILIN ROSE T
86.	VINILKANTH R V
87.	VITHYA E
88.	SUKIN S
89.	ABISHA NEYA I
90.	AJITHRA S
91.	AMIRTHAM P
92.	ANANDA ARASU T
93.	ANGELIN MARY G
94.	ANJELIN THARSHINI A
95.	ANJU P
96.	ANUSUYA A
97.	ASHTALAKSHMI M
98.	GOKUL VISWANTH
99.	JENISHA R J
100.	JUBIN JOSEPH MATHEW
101.	MAHESWARI M
102.	MAKESHWARI B
103.	MAMTHA V
104.	MICHEAL JASMINE SINDHIYA E
105.	MUKESH S
106.	MUTHU MANISHA M
107.	RAJA LAKSHMI M
108.	RAJANI CHRISH S

PRINCIPAL
ANNAI VAILANKANNI COLLEGE OF ENGINEERING
POTTALKULAM
AZHAGAPPAPURAM - 629 401
-KANYAKUMARI-DIST.

109.	REVATHI P
110.	ROHINI N
111.	SAHAYA JENIBHA Y
112.	SAHAYA KALAI SELVI B
113.	SAJIN C L
114.	SANTHINI K
115.	SATHISH KUMAR D
116.	SATHYA M
117.	SENAGA S
118.	SHERLIN BENCY B
119.	SINDHU V
120.	SIVA P
121.	SNEKA S
122.	SOBANA E
123.	SREEJITH R S
124.	SUBHA KANI S
125.	SUNITHA T
126.	SURESH L
127.	SWATHY C
128.	THANAPATTU T
129.	VALLIMAYIL A
130.	VIJAYA ROHINI C
131.	VISHALACHI M
132.	VAISHALI S
133.	THARANI S L
134.	ABARNA A F
135.	ABILASH LAWRANCE L
136.	AJEESHA S
137.	ANISHA M
138.	ANTONY MILLINOR P
139.	ASWINI SHIYANA M
140.	BEENU J B
141.	BEMELINE BLENCY LAL S L
142.	ISWARYA R
143.	JASMIN PRINCY J
144.	JENISH J
145.	MAHALEKSHMI M
146.	MONISHA R B
147.	MUPPIDATHI C
148.	MUTHUMARI P
149.	NAVARENJINI G V
150.	NITESH NETHAJI D
151.	PAVITHRA A
152.	PREETHAROSE R
153.	PRINCY A
154.	PUSHPA LATHA T
155.	RESHMA S R
156.	SEEVALAPERIYA M
157.	SHEEJA S

PRINCIPAL
ANNAI VAILANKANNI COLLEGE OF ENGINEERING
POTTALKULAM
AZHAGAPPAPURAM - 623 401
KANYAKUMARI DIST.

158.	SHERIN S V
159.	SIVA PRAKASH V
160.	SUMITHRA S
161.	SAHAYA NIVETHA
162.	Ajith R
163.	Arumugam T
164.	Franklin Mano S
165.	Jenisha S
166.	Periyasamy C
167.	Ramalingam S
168.	Sathish S
169.	Subash M
170.	Vicknesh S
171.	JINI STERLIN S M
172.	RAJESWARAJ (Long Absent)
173.	SATHIESH N
174.	ABINESH R
175.	ABIRAM A
176.	AJAY RAJAN R
177.	ANANDHU UNNIKRIHINAN
178.	ANISH THOMSON M
179.	ANTONY JEROME J
180.	ANTONY VINIS J
181.	ANTO RABY R
182.	ARUNKUMAR M
183.	ASWIN A
184.	BALA VIGNESH S
185.	CINU C
186.	CLINTON J
187.	DHARUMADURAI S
188.	ERAMIYA C
189.	FRANKLIN M
190.	GNANA MOORTHY P
191.	GOKUL P R
192.	IVIN R
193.	JENISH G R
194.	JENISH L
195.	JOSEPH ROBINSON C
196.	KAVIARASAN G
197.	KRISHNA MOORTHY S
198.	LEKSHIMANAN M
199.	MAHARAJA M
200.	MAHESWARAN N
201.	MARIA RENJITH KUMAR A
202.	MASANAM S
203.	MONISH I
204.	MUTHUKUMAR M
205.	PARTHIBAN M
206.	PRADEEP E

PRINCIPAL
 ANNAI VAILANKANNI COLLEGE OF ENGINEERING
 POTTALKULAM
 AZHAGAPPAPURAM - 629 401
 KANYAKUMARI DIST.

207.	PRASHANTH P
208.	PRATHAP S
209.	RAMALAKSHMI @ LEELAVATHI E
210.	RAMKUMAR M
211.	SAJIN N
212.	SAMSON MATHEW CHACKO
213.	SANJU C
214.	SATHEESH KUMAR M
215.	SATHESH S
216.	SATHISH KUMAR A
217.	SELVA JEROLD J
218.	SELVA LINGSON R
219.	SELVENDRAN Y
220.	SHAJU A S
221.	SHAJU S
222.	SHAJUMON S
223.	SIVA S
224.	SIVABALAN M
225.	SRI GANESH C
226.	SRI SANJAI S
227.	SUBBURAYALU M
228.	SUBRAMANIYAN M
229.	SUJITH P
230.	SURYA M
231.	SUTHAN M
232.	VASUNAMBI RAJAN K
233.	VIGNESH G
234.	VIJAY R
235.	WINSON I

COORDINATOR

HOD

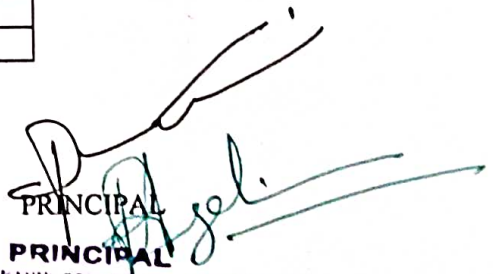
PRINCIPAL
PRINCIPAL
ANNAI VAILANKANNI COLLEGE OF ENGINEERING
POTTALKULAM
AZHAGAPPAPURAM - 629 401
KANTAKUMARI DIST.

CAREER COUNSELLING



ANNAI VAILANKANNI COLLEGE OF ENGINEERING

(Approved by AICTE, New Delhi & Affiliated to Anna University, Chennai)

AVK Nagar,, Pottalkualm, Azhagappapuram P.O.Kanyakumari District-629 401

EVENT REPORT Report on Awareness program

DATE: 20/02/2020

On 20thFebruary 2020, Seminar was conducted on “**Becoming an Entrepreneur**”at our college Training Room(MB 014). The event was organized by the Innovation and Entrepreneurship Development cell.

Er. Anto Yesuraj, CEO & Chairman of Cloud hunt Technology, presented a lecture to the final year students from various departments. He described the Role of Entrepreneurs and Innovation and presented an overview of Startups for a better understanding.



Following is the list of participants through Physical mode:

Annai Vailankanni College Of Engineering			
Attendance Sheet			
Sl.No	Name	E-mail ID	Gender
1	PRIYANKA.J	p1622918@gmail.com	Female
2	JESHIKA.S	jeshikacedrica@gmail.com	Female
3	MONISHA .M	monimanohar2002@gmail.com	Female

PRINCIPAL
ANNAI VAILANKANNI COLLEGE OF ENGINEERING
POTTALKULAM
AZHAGAPPAPURAM - 629 401
KANYAKUMARI DIST.

4	RAGUL R	raqulraj3870@gmail.com	Male
5	ASHA	Ashaanu827@gmail.com	Female
6	KAVIYA	kkaviya56989@gmail.com	Female
7	ANTO SAHAYA JAIWIN.A	Antojaiwin143@gmail.com	Male
8	ANISH. M	anishmaniharan3@gmail.com	Male
9	R.T.MONIKA	rtmonika573@gmail.com	Female
10	ASHIKA M	ashika04m@gmail.com	Female
11	RACHEL.D	rachalsy4002@gmail.com	Female
12	A.PAVITHRA	Pavithra22553@gmail.com	Female
13	SELVA THARUN R R	selvatharunrajesh@gmail.com	Male
14	SRITHAR	srihardon1234@gmail.com	Male
15	A.MARIAMMAL	maheshmuthu2728@gmail.com	Female
16	SHEKA G	shekagnanasekar@gmail.com	Female
17	K. MUGUNTHAN MANO	mugunthanmano786@gmail.com	Male
18	A.VINOTH KUMAR	vinothkumaranthony@gmail.com	Male
19	N.MINI	minineelan1@gmail.com	Female
20	K.SHANTHINI	Santhinisanthini827@gmail.com	Female
21	ADITYAN V L	adityantvm2002@gmail.com	Male
22	R V DERVIN	dervindervin179@gmail.com	Male
23	S.PRIYANKA	Priyankastephan69@gmail.com	Female
24	A.S.PONSELVI	ponselvikannan2021@gmail.com	Female
25	SELVA PRIYA J	2selvapriya3@gmail.com	Female
26	SAM.J.DUFORT	josham2428@gmail.com	Male
27	JEROME S DOMINIC	jeromedominicv@gmail.com	Male
28	SWETHA	swethaleena83@gmail.com	Female
29	M.ANITHA	lvuani90044@gmail.com	Female
30	M. DHARSHINI	dharshiniabi576@gmail.com	Female
31	D.BHARADWAJ	waibharad1616@gmail.com	Male
32	SHARMI.J	sharmiie2003@gmail.com	Female
33	C. SAJITHA	assaji983@mail.com	Female
34	L.K.SHAMILI	shamilisham82@gmail.com	Female
35	PAVITHRA.K	Pavithraapp368@gmail.com	Female
36	KAVASKER	keinskavasker@gmail.com	Male
37	THAMEEMALHUSSAIN	thameemalhussain55@gmail.com	Male
38	N. LIBINESH	libinesh5555@gmail.com	Male
39	M.ASUWATHI	asuwathim@gmail.com	Female
40	A. MANIMURUGESWARAN	manimirugan007@gmail.com	Male
41	M.DEEPAK	deepakbalor2493@gmail.com	Male
42	R. DINESH	dinesh051176@gmail.com	Male
43	E BEBIN RAJ	ebebin2004@gamil.com	Male
44	A.ANISHA	aiithdon979@gmail.com	Female
45	JENIFER	jenifer26112003@gmail.com	Female
46	E BEBIN RAJ	ebebin2004@gamil.com	Male
47	S.S.ABIJITH	abijithss2004@gmail.com	Male
48	ANISH.S	anishbeatz7@gmail.com	Male
49	A.CATHERIN ROFICA	catherinrofica@gmail.com	Female
50	SNOJA	snojachittu@gmail.com	Male
51	KEEBO A.L	keeboreus@gmail.com	Male
52	D.RAVEEN	draveen945@gmail.com	Male
53	NISHA NANTHINI M.S.	nishananthinims@gmail.com	Female

(Handwritten Signature)

54	A ABISHEK	aabishek.in26@gmail.com	Male
55	HARRIS.R	harrisharr47@gmail.com	Male
56	V.MARIAPPAN	mariappan9042753975@gmail.com	Male
57	M BRITTO SOLOMON	brittosolomon2@gmail.com	Male
58	DIVYA.M	mdivya819087@gmail.com	Female
59	PAVITHRA.P	pavi36029@gmail.com	Female
60	M. RAMAKRISHNAN	ramakrishnanmurugan04@gmail.com	Male
61	M.KANNIKA	mkannika607@gmail.com	Female
62	BAVI.K	bavibavi570@gmail.com	Female
63	JOTHI	Jothiiothi77497@gmail.com	Female
64	N.SNEHA	sneha280220042004@gmail.com	Female
65	S.RAJA	josephraja512@gmail.com	Male
66	L.JINISHA	jinishal186@gmail.com	Female
67	JEGATHEESH	jegatheeshjegatheesh049@gmail.com	Male
68	PRAKASH S	prakash642004s@gmail.com	Male
69	HARISH MAN.S	harishking8190@gmail.com	Male
70	DEVI.S	suiselvamani2002@gmail.com	Female
71	ANNIES RAVIN R	annieaa222@gmail.com	Male
72	S.SUBITHA	subikuttv678@gmail.com	Female
73	I. JOHNSON JEBASEELAN	johnson.jeba603@gmail.com	Male
74	ABINESH.R	abineshabi27123@gmail.com	Male
75	KINGSHERIN	Kungsherin27@gmail.com	Male
76	SHIJO. D	Shijomass99@gmail.com	Male
77	S.ANUSHA	Sanushaanu472@gmail.com	Female
78	M.NOUFAL	noufalmaideen2801@gmail.com	Male
79	ANU DHARSHINI N	anunagaraijan03@gmail.com	Female
80	JOSELIN SHIJO	Joselinshijo9360@gmail.com	Male
81	K. BAVITHIRA	Pavithrak8098@gmail.com	Female
82	DINESHKUMAR. K	dineshk24270@gmail.com	Male
83	NISHA. M	nishamurugesan999@gmail.com	Female
84	T. C. TINIS CHRISTAN JOE	Joemassioedon@gmail.com	Male
85	S.ISHWARYA	ss.ishwarya2004@gmail.com	Female
86	BHARATH.S	vasanthaamma62@gmail.com	Male
87	ABINESH.R	abineshabi27123@gmail.com	Male
88	SALINI.I	lr9202051@gmail.com	Female
89	ANITHA M	ivuai90044@gmail.com	Female
90	NANTHINI S	nanthiniasmi@gmail.com	Female
91	KRISHNAN	krishnankrishnan2003@gmail.com	Male
92	SUBIN	subinss390@gmail.com	Male
93	M.SIVA AKASH	sivadon685@gmail.com	Male
94	VISHWAHAR	diwavishwa08@gmail.com	Male
95	B JUDWIN DINO	binodino007@gmail.com	Male
96	ADWIN RAJ R	adwinking22@gmail.com	Male
97	HARISH KRISHNAN	directorc0012003@gmail.com	Male
98	JENITH J	jjenith434@gmail.com	Male
99	JINO A	jinoaj2004@gmail.com	Male
100	MICHAEL SUJIN X	miandlin82@gmail.com	Male
101	NITHIN REHOBOTH SALAL	salalnithi@gmail.com	Male
102	SUBITHA A	subitha645@gmail.com	Female
103	THANAMSEELAN C	sheelansheelan916@gmail.com	Male

Aggel

104	VIJAY PRASAS VV	vijayprasad512004@gmail.com	Male
105	A ASHA	ashadhas304@gmail.com	Female
106	BELSI MARY S	blesimary992@gmail.com	Female
107	J JEBIN	mroggy102@gmail.com	Male
108	J SUBISHA	subishajayakumar99@gmail.com	Female
109	S MITHUNA	mithunamithuna512@gmail.com	Female
110	LIJU.L	liju.liju2002@gmail.com	Male
111	AKALYA. M	akalyaavce@gmail.com	Female
112	DHANESH	dhaneshece2018@gmail.com	Male
113	MABLE VIMALA S	mable.s140302@gmail.com	Female
114	N.AKILAN	akilanece2019@gmail.com	Male
115	JERISHA C	jerishac2001@gmail.com	Female
116	SARANYA.T	saranyathanqarajendran@gmail.com	Female
117	NANTHINI.NS	nanthini2001ns@gmail.com	Female
118	NAVEEN KUMAR S	naveen20062002@gmail.com	Male
119	BABISHA M	babishamurugan@gmail.com	Female
120	R.THANA REKA	thanareka18@gmail.com	Female
121	V. KAVITHA	VSkavitha811@gmail.com	Female
122	A.NANTHINI	ananthini143@gmail.com	Female
123	PONSEKAR. C	ponsekar003@gmail.com	Male
124	SANTHOSH.G	santhoshiyappan456@gmail.com	Male

I hereby submit the report for your kind perusal.

Thank you,

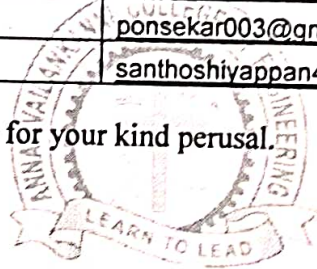

Prof. Lalu Gladson Robin,
Coordinator,
Entrepreneurship Development Cell,
Annai Vailankanni College of Engineering.

PRINCIPAL
ANNAI VAILANKANNI COLLEGE OF ENGINEERING
POTTALKULAM
AZHAGAPPAPURAM - 629 401
KANYAKUMARI DIST.



ANNAI VAILANKANNI COLLEGE OF ENGINEERING
(Approved by AICTE, New Delhi & Affiliated to Anna University, Chennai)
AVK Nagar,, Pottalkulam, Azhagappapuram P.O.Kanyakumari District-629 401
Event Report

Name of the programme/Activity: Time Management in Examination"	
Date: : 26/11/2019	Time : 10a.m -12 p.m
Venue :Conference Hall	Total participants:235
ECC ACADEMY	



Annal vallankanni college of Engineering
APPROVED BY AICTE, NEW DELHI & AFFILIATED TO ANNA UNIVERSITY, CHENNAI
A.V.K. NAGAR, POTHAIYADI SALAI, POTTALKULAM, AZHAGAPPAPURAM,
KANYAKUMARI, TAMILNADU-629401

Time Management in Examination
PRESENTED BY
ECC ACADEMY

Date: 26/11/2019 Venue:Conference Hall

Report:
The department of EEE,CSE,CIVIL,MECH and ECE, are jointly organize a program on "Time Management in Examination" at our college on 26/11/2019 by ECC Academy, Nagercoil-01.He explained how to manage the time while writing the exam and also he explained the short cut way of problem solving .

NAME LIST

1.	ABISHA BARM
2.	ANTANY NIMITHA S
3.	ARUN BENNY
4.	ASWITHA T
5.	DIVYA M
6.	FEMIL SHANI
7.	JEEVAN JEDLY G
8.	MEKALA DEVI
9.	PAVITHRA A
10.	REENA

PRINCIPAL
ANNAI VAILANKANNI COLLEGE OF ENGINEERING
POTTALKULAM
AZHAGAPPAPURAM - 629 401
KANYAKUMARI DIST.

5.1.3 Percentage of students benefitted by guidance for competitive examinations and career counselling offered by the Institution

Year	Guidance for competitive examinations			Details of career counselling		
	Name of the Activity	Number of students participated	Number of students qualified in the competitive examinations	Name of the Activity	Number of students participated	Number of students place
2022-2023	ECC Academy-Civil service	67		Career guidance program-Varenda	67	62
				Career guidance program-Knowit	67	
			Nil	TNSI awareness camp	67	
				Awareness Program on "Becoming an Entrepreneur"	124	
2021-2022	Awareness&Quiz on Gate -UN academy	100		Awareness Program on "One Million Ideas"	60	78
				Awareness Program on "Intellectual Property Rights"	124	
			Nil	Placement & Enteprenership Opportunities	100	
				Empowering Women through skill development	95	
2020-2021	Aptitude Training by FACE	65		Aptitude and Soft skill training by Naandhi	96	63
			Nil			
2019-2020	Time Management In Examination -ECC Academy	235	Nil	Awareness program on "Becoming an Entrepreneur"	124	61

2018-2019	Awareness Session on UPSC/TNPSC	250		Personality Development Program	76	40
			1			

COMPETITIVE EXAMINATIONS



ANNAI VAILANKANNI

College of Engineering

REPORT



on

Aptitude Training by

FACE

conducted from

16/12/2021 to 22/12/2021

Training and Placement Cell

Report on Aptitude training from 16th to 22nd December 2021

FACE (Focus 4D Career Education Pvt. Ltd.) conducted a 5-day Aptitude training from the 16th to the 22nd of December 2021, excluding Saturday and Sunday. Ms. Sangeetha (phone: 8489140129) was the instructor. A total of 65 students participated in the training programme, which was held in the BOSCH training room on the campus of our college. Following is the list of students

S.No.	Name of the Student	Dept
1	M Bala Murugan	IV CSE
2	R Deva	
3	A Rakesh	
4	A Mariya	
5	V Kousalya	
6	K Siva Subatha	
7	A Arockia Divya	
8	R Delma Rose	
9	M Dinesh	
10	R Ramasamy	
11	D Godwin	
12	B Janani	
13	A Selva Sutha	
14	J Abisha Mol	
15	Asiba	
16	J Jeba Reshma	
17	D Masana Malathi	
18	Jeevitha D	
19	Bibisha	IV ECE
20	Akila	
21	Pavithra	
22	Masanam	
23	Inba Mukila	
24	Ramalakshimi	
25	Jensi	
26	Suleabha	



PRINCIPAL
ANNAI VAILANKANNI COLLEGE OF ENGINEERING
POTTALKULAM
AZHAGAPPAPURAM - 629 401
KANYAKUMARI DIST.

27	Muthu Bharathi	IV EEE
28	Ajith M	
29	Arun P J	
30	Jins Jebadhas	
31	Senthil R	
32	Uma	III Civil
33	A Chitra	
34	Annie Stephila	IV Civil
35	Muthu Siva Subramanian	
36	Sujin Ganesh	IV Mech
37	Venkatesh	
38	Ajay Kumar	
39	Rithish	
40	Antony Kishore	
41	Abimanyu	
42	Arun Rakesh	
43	Siva Kumar	
44	Suyambu Lingam	
45	Bharathi Raja	
46	Kings	
47	Aravind Raj	
48	Glaxton Samuel	
49	Abinesh Antony	
50	Rabisha	
51	Nanthinini A	
52	Santhosh	
53	Pon Sekar	
54	Liju	
55	Akilan	
56	Kavitha V	
57	M Akalya	
58	S Aarthi	
59	R Thana Reka	
60	M Babisha	
61	C Jerisha	
62	T Saranya	

PRINCIPAL
ANNAI VAILANKANNI COLLEGE OF ENGINEERING
POTTALKULAM
AZHAGAPPAPURAM - 629 401
KANTHAKUMARI DIST.

63	Mable Vimala	
64	Nanthinini N S:	
65	Viswa	IV Mech

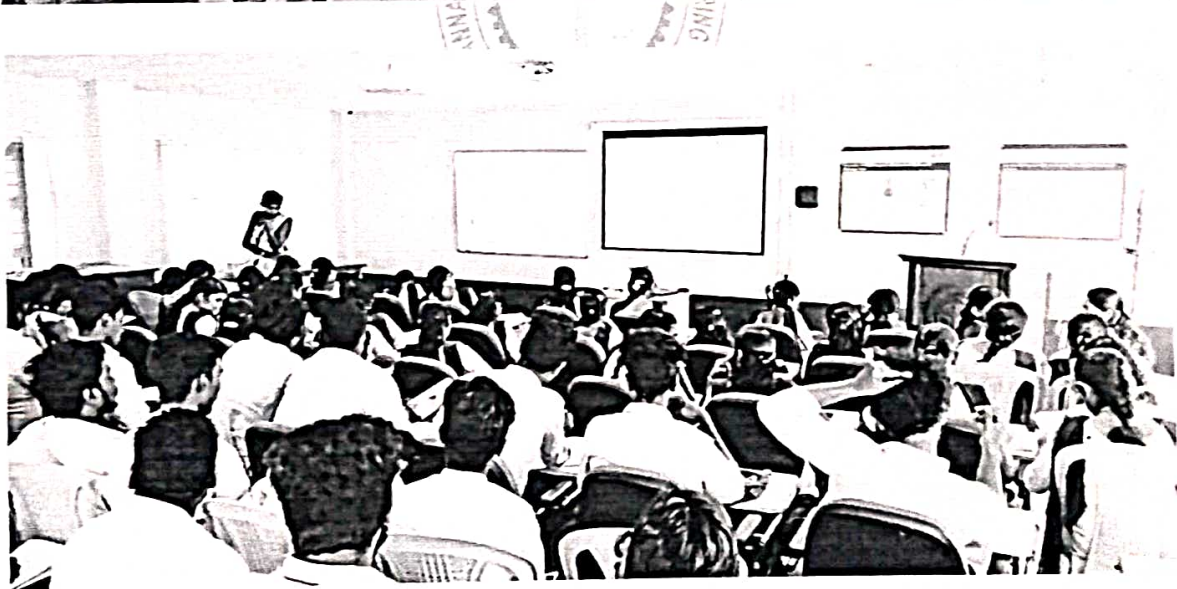
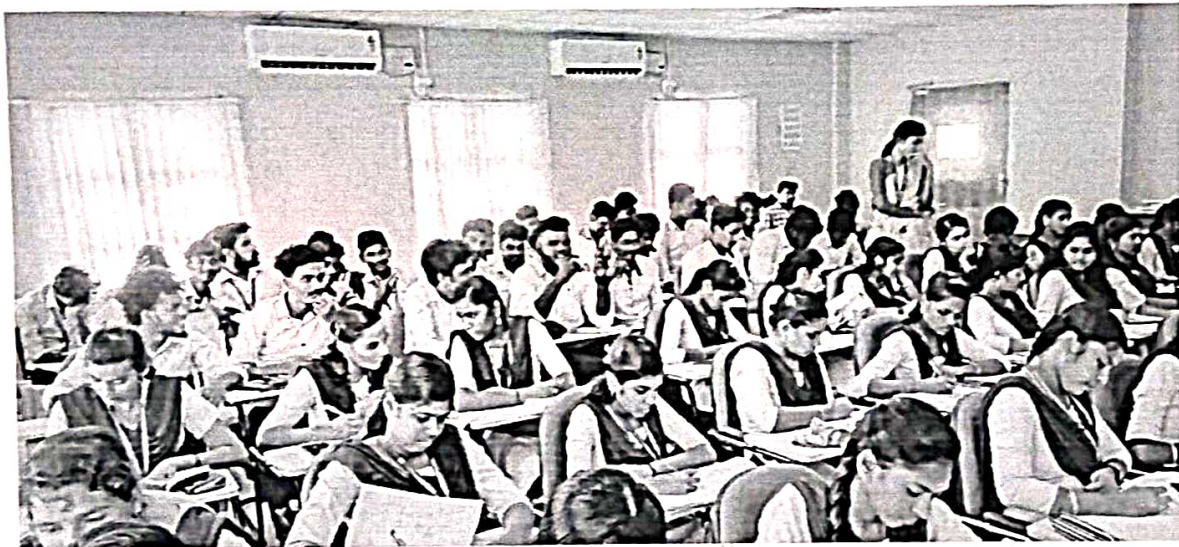
Because this is a paid course, each student was charged Rs700. The entire amount collected was Rs45,500, of which Rs40,000 was paid to Focus 4D Career Education Pvt. Ltd. (Invoice copy attached).



Ageli
PRINCIPAL
ANNALAI VARLANKANNAR COLLEGE OF ENGINEERING
POTTALKULAM
AZHAGAPPAPURAM - 629 401
KANTAKUMARI DIST.

Focus 4D Career Education Pvt Ltd
FOCUS 4D CAREER EDUCATION PVT LTD
Coimbatore, Tamilnadu 641014
IN
Invoice@focusacademy.in
GSTIN: 33AABCF3266F1ZZ
PAN No. AABCF3266F

TAX INVOICE

BILL TO

ANNAI VAILANKANNI
COLLEGE OF ENGINEERING
AVK Nagar, Azhagappapuram
Post,
Kanyakumari District,
Tamil Nadu 629 401 India
State Code: 33

TAX INVOICE NO. FACE/2022/0637
DATE 30/12/2021

PLACE OF SUPPLY

33 - Tamil Nadu

DEAL NO :
N22564

PAID

NO	HSN/SAC	DESCRIPTION	TOTAL AMOUNT	
1	999293	Aptitude Training Program 2022 Passouts	33,898.00	
Account Type: Current			SUBTOTAL	33,898.00
Bank Name: CITY UNION BANK LIMITED			CGST @ 9% on 33898.00	3,050.82
Branch Name: VILANKURICHI BRANCH COIMBATORE			SGST @ 9% on 33898.00	3,050.82
A/C NO: 053109000142765			TOTAL	39,999.64
IFSC Code: CIUB0000053			PAYMENT	40,000.00
For cheque payments: Cheque to be made in favour of M/s. Focus 4-D Career Education Pvt. Ltd			ROUND OFF AMOUNT	0.36
Terms:			BALANCE DUE	₹0.00
- Amount payable is inclusive of all levies and charges				
- All disputes are subject to Coimbatore Jurisdiction Only.				
- Delay in payment beyond the agreed terms will attract an interest of 23% per annum on the Outstanding Amount				

This is a digitally signed document and doesn't require any signature

This report includes images and a copy of the invoice for your convenience.

Thank you,

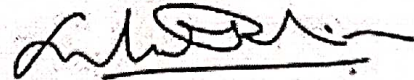

Prof. Lalu Gladson Robin,
Head,
Training and Placement Cell,
Annai Vailankanni College of Engineering.



PRINCIPAL
ANNAI VAILANKANNI COLLEGE OF ENGINEERING
POTTALKULAM
AZHAGAPPAPURAM - 629 401
KANTAKUMARI DIST.

CAREER COUNSELLING



ANNAI VAILANKANNI

College of Engineering

REPORT

on

Aptitude & Soft Skills Training by

Naandi Foundation in association with Titan LeAP

conducted from

27/12/2021 to 31/12/2021

Training and Placement Cell

Report on Aptitude and Soft skills training from 27th to 31st December 2021

Naandi Foundation in association with Titan LeAP conducted a 5-day Aptitude and Soft skills training from the 27th to the 31st of December 2021. Mr. Ganesh Babu (phone: 9994391312) was the Aptitude instructor and Mr. Revanth Bommu was the Soft skills instructor. A total of 96 final year students (Batch-1 = 53; Batch -2 = 43) participated in the training programme, which was held in the BOSCH training room and Robotics Lab on the campus of our college. Following is the list of students.

BATCH - 1		
1	L MANIKANDAN	MECH
2	M NITHIN BABU	MECH
3	A VIJAY PRAKASH	MECH
4	M NITHYANANTHAN	MECH
5	T MUTHU KUMAR	CSE
6	R DEVA	CSE
7	S ESAKI SABARISHVARAN	CSE
8	A RAKESH	CSE
9	A MICHEAL FRANCIS KISHORE	CSE
10	S MUTHU KANNAN	CSE
11	M DINESH	CSE
12	E BARATHI RAJA	MECH
13	I MUTHU KUMAR GANESH	MECH
14	S ANTONY MICHEAL	CSE
15	A MUTHU VENKATESH	MECH



PRINCIPAL
ANNAL VAILANKANNI COLLEGE OF ENGINEERING
POTTALKULAM
AZHAGAPPAPURAM - 629 401
KANYAKUMARI DIST.

16	S UTHAYA DURAI	MECH
17	P MANOJI	MECH
18	M BALA MURUGAN	CSE
19	A ABINESH ANTONY	MECH
20	K SIVA KUMAR	MECH
21	K SIVA SUBATHA	CSE
22	S VISHWA	MECH
23	J UMA GANESH	MECH
24	S MUTHU KUMAR	MECH
25	V KAUSALAYA	CSE
26	T PRIYA	CSE
27	M MUTHU BHARATHI	CSE
28	A NISHA	CSE
29	C SUBHASHINI	CSE
30	S DEVI	CSE
31	A SINTHUJA	CSE
32	N ABITHA	CSE
33	D MASANA MALATHI	CSE
34	A AROCKIA DIVYA	CSE
35	G ANTONY KISHORE	MECH
36	S SUYAMBU LINGAM	MECH
37	G AJAY KUMAR	MECH
38	V RITHISH	MECH
39	R ARUN RAKESH	MECH
40	M ABIMANYU	MECH
41	G GLAXTON SHAMUVEL	MECH
42	A ARVAINTH RAJ	MECH
43	K KINGS	MECH
44	R MURUGAMMAL	CSE
45	B ESAKKI DEVI	CSE
46	A MARIYA	CSE
47	K ARUN PRAKASH	MECH
48	V VINOOTH	MECH

PRINCIPAL

ANNAL VAILANKANNI COLLEGE OF ENGINEERING
POTTAL KULAM
AZHAGAPPAPURAM - 629 401
KANYAKUMARI DIST.

49	J ANTO JEBIN	MECH
50	D STEFFIN GEORGE	MECH
51	A SUJIN GANESH	MECH
52	R RAJESH KUMAR	MECH
53	C VENKATESH	MECH
	BATCH - 2	
1	M KALAI SELVAN	CIVIL
2	S ARUN KUMAR	EEE
3	MUTHU SIVA SUBRA MANIAN	CIVIL
4	G AROCKIA STANLIN PRAKASH	ECE
5	C ESAKKI MUTHU	CIVIL
6	M SUJITH	EEE
7	S SURESH RAJA	CIVIL
8	R ABINESH	CIVIL
9	S JINS JEBA DHAS	EEE
10	R SENTHIL	EEE
11	E SANJAY KUMAR	ECE
12	A MUTHU BHARATHI	EEE
13	M MANJU	CSE
14	SABARISHA	CSE
15	S EMIMAL	CSE
16	A SELVA SUTHA	CSE
17	J ABISHA MOL	CSE
18	A ASIBA	CSE
19	B JANANI	CSE
20	J JEBA RESHMA	CSE
21	R DELMA ROSE	CSE
22	S MALLIKA	CSE
23	P PONNAZAGU MONISHA	CIVIL
24	ANNIE STEPHILA	CIVIL
25	B KARTHIKA	CIVIL
26	T RAMA LAKSHMI	ECE
27	C INBA MUKILA	ECE
28	P DIVYA JOTHI	EEE
29	Y JENSI	ECE
30	M SULAEBHA	ECE

PRINCIPAL
 ANNAI VAILANKANNI COLLEGE OF ENGINEERING
 POTTALKULAM
 AZHAGAPPAPURAM - 629 401
 KANYAKUMARI DIST.

31	M BIBISHA	ECE
32	R AKILA	ECE
33	M PAVITHRA	ECE
34	E MASANAM	ECE
35	B INDHU MATHI	ECE
36	R SUMITHA	ECE
37	SUBATHRA S	ECE
38	M AJITH	EEE
39	V DINESH	EEE
40	R RAMASAMY	CSC
41	D GODWIN	CSC
42	O SRINATH	CIVIL
43	ARUN	EEE



ANNAI VAILANKANNI COLLEGE OF ENGINEERING

In Association with



A CSR initiative by Titan Company Ltd.
for skill development



Proudly presents

5 Days Skill Development Program
Aptitude & Soft skills training
From 27th to 31st December 2021

www.avce.edu.in

Training and Placement Cell

PRINCIPAL
ANNAI VAILANKANNI COLLEGE OF ENGINEERING
POTTALKULAM
AZHAGAPPAPURAM - 629 401
KANYAKUMARI DIST.

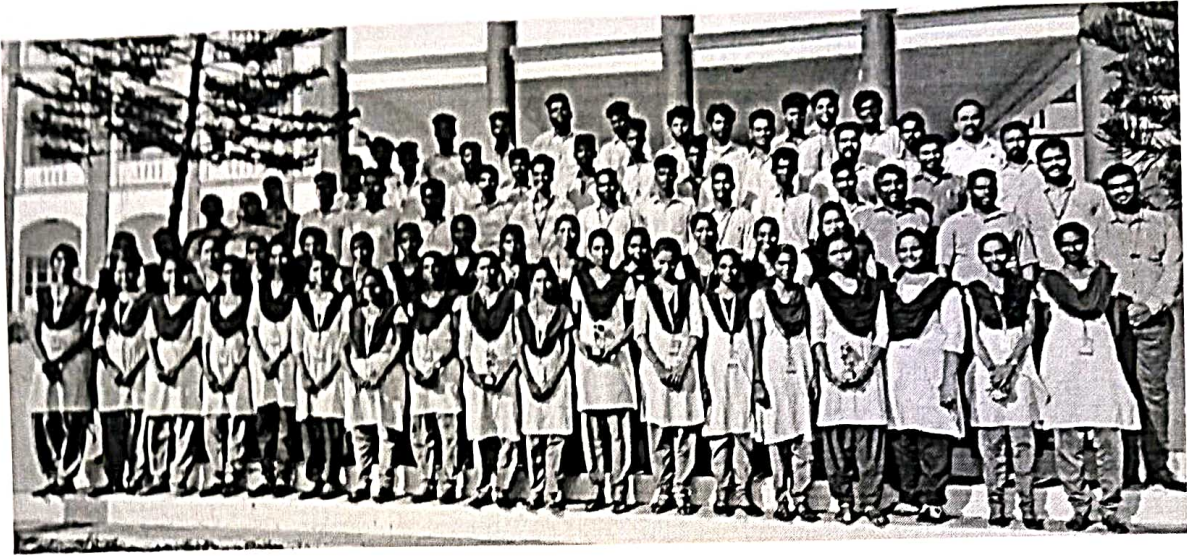

During the validictory function, the top eight students were recognised. The list of students is as follows: Mr. Ajay Kumar (MECH), Mr. Arun Rakesh (MECH), Ms. Malika (CSE), Ms. Muthu Bharathi (CSE), Ms. Arockia Divya (CSE), Ms. Subathra (ECE), Mr. Arockia Stanlin Prakash (ECE), Mr. Muthu Siva Subramanian (CIVIL).

PRINCIPAL
ANNAI VAILANKANNI COLLEGE OF ENGINEERING
POTTALKULAM
AZHAGAPPAPURAM - 629 401
KANYAKUMARI DIST.

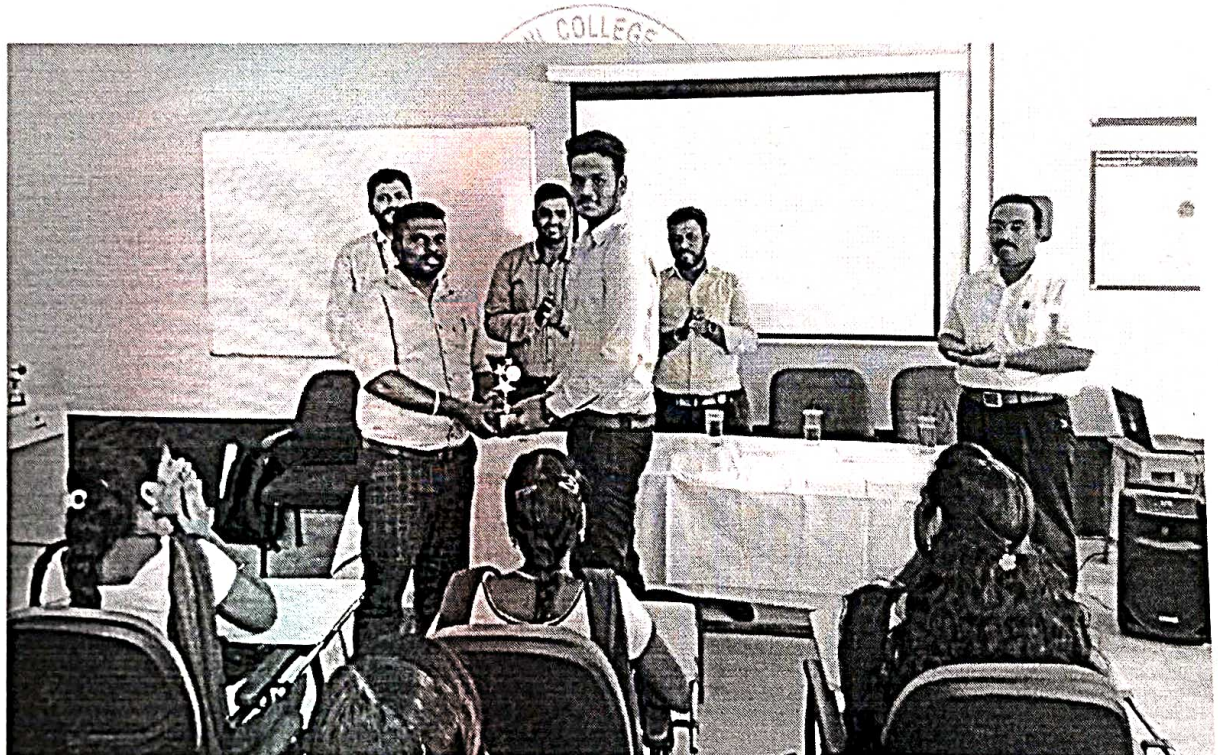



D. Sel.
PRINCIPAL
ANNAI VAILANKANNI COLLEGE OF ENGINEERING
POTTALKULAM
AZHAGAPPAPURAM - 629 401
KANYAKUMARI DIST.





PRINCIPAL
ANNAI VAILANKANNI COLLEGE OF ENGINEERING
POTTALKULAM
AZHAGAPPAPURAM - 629 401
KANYAKUMARI DIST.



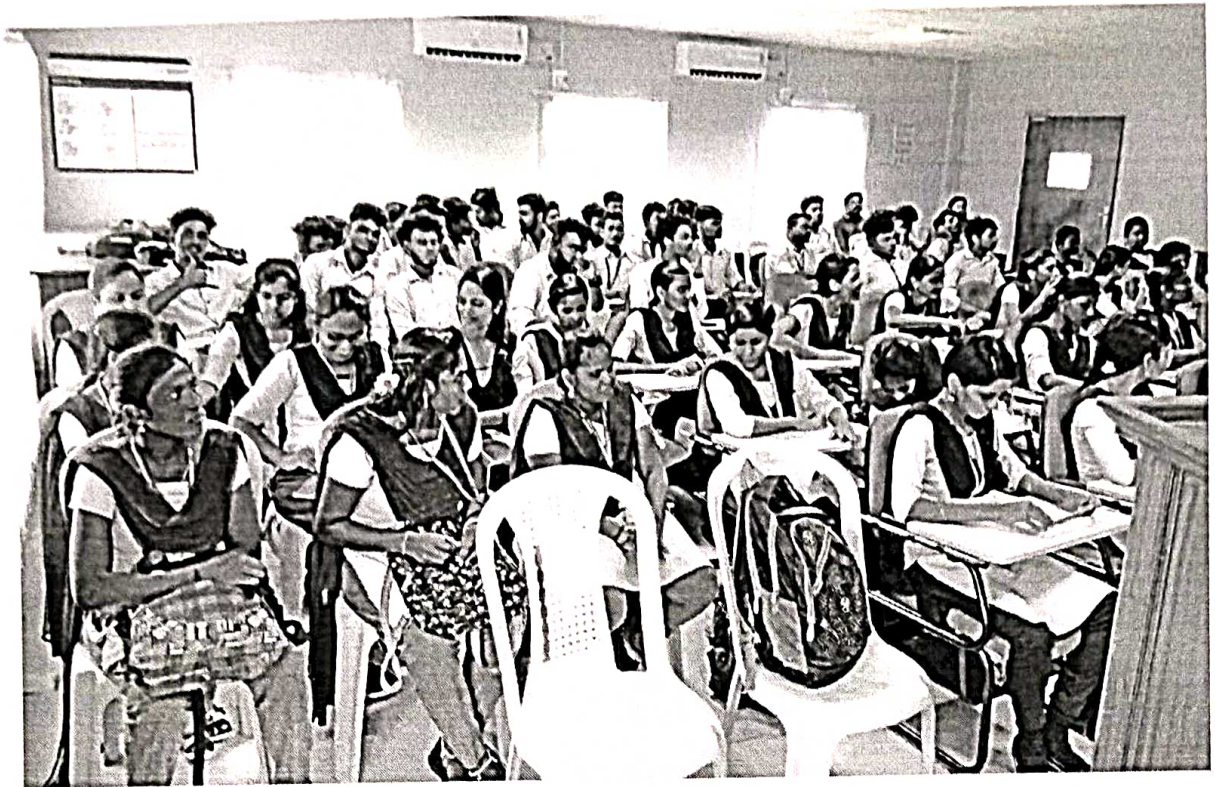

Ajel

PRINCIPAL
ANNAI VAILANKANNI COLLEGE OF ENGINEERING
POTTALKULAM
AZHAGAPPURAM - 629 401
KANYAKUMARI DIST.

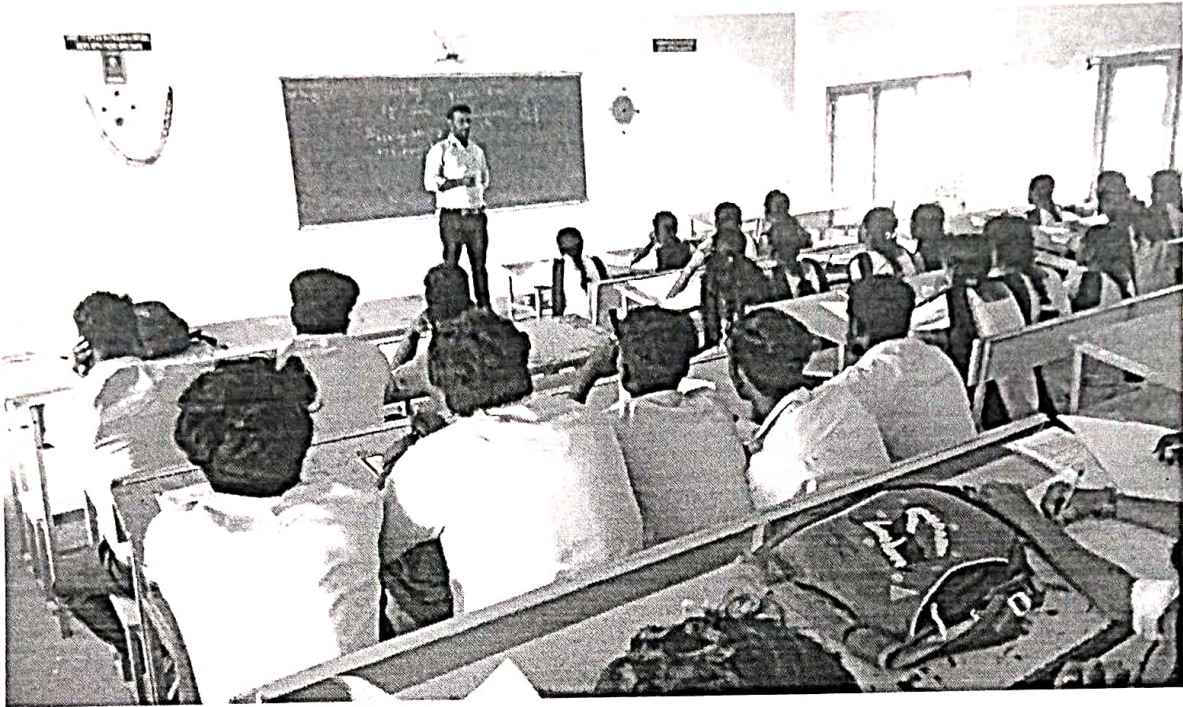

Agel
PRINCIPAL
ANNAI VAILANKANNI COLLEGE OF ENGINEERING
POTTALKULAM
AZHAGAPPAPURAM 629 401
KANYAKUMARI DIST.



PRINCIPAL
ANNAI VAILANKANNI COLLEGE OF ENGINEERING
POTTALKULAM
AZHAGAPPAPURAM - 629 401
KANYAKUMARI DIST.



A. Sel.
PRINCIPAL
ANNAL VAILANKANNI COLLEGE OF ENGINEERING
POTTALKULAM
AZHAGAPPAPURAM - 629 401
KANYAKUMARI DIST.



PRINCIPAL
ANNAI VAILANKANNI COLLEGE OF ENGINEERING
POTTALKULAM
AZHAGAPPAPURAM - 629 401
KANNYAKUMARI DIST.



ANNAI VAILANKANNI COLLEGE OF ENGINEERING
(Approved by AICTE, New Delhi & Affiliated to Anna University, Chennai)
AVK Nagar,, Pottalkulam, Azhagappapuram P.O.kanyakumari District-629 401



Department of Training and Placement

5 Days Skill Development Programme
Aptitude & Soft skills training
27th to 31st December 2021



Valedictory Ceremony

Programme Schedule

3:10 pm	Welcome address	Mr. Lalu Gladson Robin, TPO
3:12 pm	Principal address	Dr. A. Benham, Principal
3:20 pm	Feedback session:	
3:30 pm	Distribution of awards	Mr. Manikandan, Manager
3:35 pm	Vote of thanks	Dr. J. Sunil, Vice-Principal

Attendance Sheet:

Sl. No.	Name	Department	Batch	27/12/21		28/12/21		29/12/21		30/12/21		31/12/21		Present Out of 10
				FN	AN	FN	AN	FN	AN	FN	AN	FN	AN	
1	L MANIKANDAN	MECH	1	P	A	A	A	A	A	A	A	A	A	1
2	M NITHIN BABU	MECH	1	P	A	A	A	A	A	A	A	A	A	1
3	A VIJAY PRAKASH	MECH	1	P	A	A	A	A	A	A	A	A	A	1
4	M NITHYANANTHAN	MECH	1	P	P	A	A	A	A	P	P	A	A	4
5	T MUTHU KUMAR	CSE	1	P	P	P	P	A	A	P	P	A	A	6

PRINCIPAL
ANNAI VAILANKANNI COLLEGE OF ENGINEERING
POTTALKULAM
AZHAGAPPAPURAM - 629 401
KANYAKUMARI DIST.

6	R DEVA	CSE	1	P	P	A	A	P	P	P	P	P	P	8
7	S ESAKI SABARISHVARAN	CSE	1	P	P	P	P	A	A	P	P	P	P	8
8	A RAKESH	CSE	1	P	P	P	P	P	P	P	P	A	A	8
9	A MICHEAL FRANCIS KISHORE	CSE	1	P	P	P	P	A	A	P	P	A	A	6
10	S MUTHU KANNAN	CSE	1	P	P	P	P	A	A	P	P	A	A	6
11	M DINESH	CSE	1	P	P	P	P	P	P	P	A	A	A	7
12	E BARATHI RAJA	MECH	1	P	P	P	P	P	P	P	P	P	P	10
13	I MUTHU KUMAR GANESH	MECH	1	P	P	P	P	A	A	P	P	A	A	6
14	S ANTONY MICHEAL	CSE	1	P	P	A	A	A	A	A	A	A	A	2
15	A MUTHU VENKATESH	MECH	1	P	P	P	P	P	P	P	P	P	P	10
16	S UTHAYA DURAI	MECH	1	P	P	P	P	P	P	P	P	P	P	10
17	P MANOJI	MECH	1	P	P	A	A	A	A	A	A	A	A	2
18	M BALA MURUGAN	CSE	1	P	P	P	P	P	P	P	P	A	A	8
19	A ABINESH ANTONY	MECH	1	P	P	A	A	P	P	P	P	P	P	8
20	K SIVA KUMAR	MECH	1	P	P	P	P	P	P	P	P	P	P	10
21	K SIVA SUBATHA	CSE	1	P	P	P	P	P	P	P	P	P	P	10
22	S VISHWA	MECH	1	P	P	P	P	A	A	A	A	A	A	4
23	J UMA GANESH	MECH	1	P	P	A	A	A	A	A	A	A	A	2
24	S MUTHU KUMAR	MECH	1	P	P	P	P	A	A	P	P	A	A	6
25	V KAUSALAYA	CSE	1	P	P	P	P	A	P	P	P	P	P	9
26	T PRIYA	CSE	1	P	P	P	P	P	P	P	P	P	P	10
27	M MUTHU BHARATHI	CSE	1	P	P	P	P	P	P	P	P	P	P	10
28	A NISHA	CSE	1	P	P	P	P	P	P	P	P	P	P	10
29	C SUBHASHINI	CSE	1	P	P	P	P	P	P	P	P	P	P	10
30	S DEVI	CSE	1	P	P	P	P	P	P	A	A	P	P	8
31	A SINTHUJA	CSE	1	P	P	P	P	P	P	A	A	A	A	6
32	N ABITHA	CSE	1	P	P	P	P	P	P	P	P	P	P	10

PRINCIPAL
 ANNAI VAILANKANNI COLLEGE OF ENGINEERING
 POTTALKULAM
 AZHAGAPPAPURAM - 629 401
 KANTAKUMARI DIST.

33	D MASANA MALATHI	CSE	1	P	P	P	P	P	P	P	P	P	P	10
34	A AROCKIA DIVYA	CSE	1	P	P	P	P	P	P	P	P	P	P	10
35	G ANTONY KISHORE	MECH	1	P	P	P	P	P	P	P	P	P	P	10
36	S SUYAMBU LINGAM	MECH	1	P	P	A	A	A	A	A	A	A	A	2
37	G AJAY KUMAR	MECH	1	P	P	P	P	P	P	P	P	P	P	10
38	V RITHISH	MECH	1	P	P	P	P	P	P	P	P	P	P	10
39	R ARUN RAKESH	MECH	1	P	P	P	P	P	P	P	P	P	P	10
40	M ABIMANYU	MECH	1	P	P	P	P	P	P	A	A	P	P	8
41	G GLAXTON SHAMUVEL	MECH	1	P	P	A	A	P	P	P	P	P	P	8
42	A ARVAINTH RAJ	MECH	1	P	P	A	A	P	P	P	P	P	P	8
43	K KINGS	MECH	1	P	P	A	A	P	P	P	P	P	P	8
44	R MURUGAMMAL	CSE	1	A	A	P	P	P	P	P	P	P	P	8
45	B ESAKKI DEVI	CSE	1	A	A	P	P	A	A	P	P	P	P	6
46	A MARIYA	CSE	1	A	A	P	P	P	P	P	P	P	P	8
47	K ARUN PRAKASH	MECH	1	A	A	P	P	P	P	A	A	P	P	6
48	V VINOTH	MECH	1	A	A	P	P	P	P	P	A	A	A	5
49	J ANTO JEBIN	MECH	1	A	A	P	A	A	A	A	A	A	A	1
50	D STEFFIN GEORGE	MECH	1	A	A	P	P	P	P	A	A	A	A	4
51	A SUJIN GANESH	MECH	1	A	A	P	P	P	P	P	P	P	P	8
52	R RAJESH KUMAR	MECH	1	A	A	P	P	P	P	P	P	A	A	6
53	C VENKATESH	MECH	1	A	A	P	P	P	P	P	P	P	P	8
	BATCH - 2													0
1	M KALAI SELVAN	CIVIL	2	P	P	P	P	P	P	P	P	P	P	10
2	S ARUN KUMAR	EEE	2	P	P	P	P	P	P	P	P	P	P	10
3	MUTHU SIVA SUBRA MANIAN	CIVIL	2	P	P	P	P	P	P	P	P	P	P	10
4	G AROCKIA STANLIN PRAKASH	ECE	2	P	P	P	P	A	A	P	P	P	P	8
5	C ESAKKI MUTHU	CIVIL	2	P	P	P	P	P	P	P	P	P	P	10
6	M SUJITH	EEE	2	P	P	P	P	P	P	P	P	P	P	10
7	S SURESH RAJA	CIVIL	2	P	P	P	P	P	P	P	P	P	P	10
8	R ABINESH	CIVIL	2	P	P	P	P	P	P	P	P	P	P	10
9	S JINS JEBHA DHAS	EEE	2	P	P	P	P	P	A	P	P	A	A	7
10	R SENTHIL	EEE	2	P	P	P	P	P	P	P	P	P	P	10
11	E SANJAY KUMAR	ECE	2	P	P	P	A	A	A	P	P	P	P	7
12	A MUTHU BHARATHI	EEE	2	P	P	A	A	P	A	A	A	A	A	3

PRINCIPAL
 ANNAL VAILANKANNI COLLEGE OF ENGINEERING
 POTTALKULAM
 AZHAGAPPAPURAM - 629 301
 KANYAKUMARI DIST.

13	M MANJU	CSE	2	P	P	A	A	P	P	P	P	P	A	7
14	SABARISHA	CSE	2	P	P	A	A	P	P	P	P	A	A	6
15	S EMIMAL	CSE	2	P	P	P	P	A	A	P	P	A	A	6
16	A SELVA SUTHA	CSE	2	P	P	P	P	P	P	P	P	P	P	10
17	J ABISHA MOL	CSE	2	P	P	P	P	P	P	P	P	P	P	10
18	A ASIBA	CSE	2	P	P	P	P	P	P	P	P	P	P	10
19	B JANANI	CSE	2	P	P	P	P	A	A	P	P	P	P	8
20	J JEBA RESHMA	CSE	2	P	P	P	P	P	P	P	P	P	P	10
21	R DELMA ROSE	CSE	2	P	P	P	P	A	A	P	P	P	P	8
22	S MALLIKA	CSE	2	P	P	P	P	P	P	P	P	P	P	10
23	P PONNAZAGU MONISHA	CIVIL	2	P	P	P	P	P	P	P	P	P	P	10
24	ANNIE STEPHILA	CIVIL	2	P	P	A	A	A	A	P	P	P	P	6
25	B KARTHIKA	CIVIL	2	P	P	P	P	P	P	P	P	P	P	10
26	T RAMA LAKSHMI	ECE	2	P	P	P	P	P	P	P	P	A	A	8
27	C INBA MUKILA	ECE	2	P	P	P	P	P	P	P	P	P	P	10
28	P DIVYA JOTHI	EEE	2	P	P	P	P	P	P	P	P	A	A	8
29	Y JENSI	ECE	2	P	P	P	P	P	P	P	P	P	P	10
30	M SULAEBHA	ECE	2	P	P	P	P	P	P	P	P	P	P	10
31	M BIBISHA	ECE	2	P	P	A	A	P	P	P	P	P	P	8
32	R AKILA	ECE	2	P	P	P	P	P	P	P	P	P	P	10
33	M PAVITHRA	ECE	2	P	P	P	P	P	P	P	P	P	P	10
34	E MASANAM	ECE	2	P	P	P	P	P	P	P	P	P	P	10
35	B INDHU MATHI	ECE	2	P	P	P	P	P	P	P	P	A	A	8
36	R SUMITHA	ECE	2	P	P	P	P	P	P	P	P	P	P	10
37	SUBATHRA S	ECE	2	P	P	P	P	P	P	P	P	P	P	10
38	M AJITH	EEE	2	A	A	P	P	P	P	P	P	A	A	6
39	V DINESH	EEE	2	A	A	A	A	P	P	P	P	A	A	4
40	R RAMASAMY	CSC	2	A	A	A	A	P	P	P	P	P	P	6
41	D GODWMN	CSC	2	A	A	A	A	P	P	P	P	A	A	4
42	O SRINATH	CIVIL	2	A	A	A	A	P	P	P	P	P	P	6
43	ARUN	EEE	2	A	A	A	A	A	A	P	P	P	P	4

PRINCIPAL
 ANNAL VAILANKANNI COLLEGE OF ENGINEERING
 POTTALKULAM
 AZHAGAPPURAM 623 401
 KANYAKUMARI DIST.

Attendance	No. of Students
10/10	39
9/10	1
8/10	21
7/10	4
6/10	15
5/10	1
4/10	6
3/10	1
2/10	4
1/10	4
Total	96

This report includes images and a copy of the attendance sheet for your convenience.

Thank you,



Prof. Lalu Gladson Robin,
Head,
Training and Placement Cell,
Annai Vailankanni College of Engineering.

PRINCIPAL
ANNAI VAILANKANNI COLLEGE OF ENGINEERING
POTTALKULAM
AZHAGAPPAPURAM - 629 401
KANYAKUMARI DIST.

5.1.3 Percentage of students benefitted by guidance for competitive examinations and career counselling offered by the institution

Year	Guidance for competitive examinations			Details of career counselling		
	Name of the Activity	Number of students participated	Number of students qualified in the competitive examinations	Name of the Activity	Number of students participated	Number of students place
2022-2023	ECC Academy-Civil service	67		Career guidance program-Varenda	67	62
				Career guidance program-Knowit	67	
			Nil	TNSI awareness camp	67	
				Awareness Program on "Becoming an Entrepreneur"	124	
2021-2022	Awareness & Quiz on Gate -UN academy	100		Awareness Program on "One Million Ideas"	60	78
				Awareness Program on "Intellectual Property Rights"	124	
			Nil	Placement & Entrepreneurship Opportunities	100	
				Empowering Women through skill development	95	
2020-2021	Aptitude Training by FACE	65		Aptitude and Soft skill training by Naandhi	96	63
			Nil			
2019-2020	Time Management in Examination -ECC Academy	235	Nil	Awareness program on "Becoming an Entrepreneur"	124	61

2018-2019	Awareness Session on UPSC/TNPSC	250		Personality Development Program	76	40
				1		

COMPETITIVE EXAMINATIONS



ANNAI VAILANKANNI COLLEGE OF ENGINEERING
(Approved by AICTE, New Delhi & Affiliated to Anna University, Chennai)
K Nagar, Pothaiyadi Salai, Azhagappapuram Post, K.K. Dist – 629 401

REPORT

LEGAL AWARENESS PROGRAM

The Department of Science and Humanities organized a Legal Awareness program for the first-year students at our college on **October 29, 2021**. The program coordinator Mrs. Shijula Lindry AP/Chemistry delivered the welcome address. Dr. A. Benham, Principal presided over the meeting and delivered the presidential address. He insisted on the importance of creating legal awareness and vigilance awareness among the students. Er. David Philip Daniel, Director explained the aim and importance of vigilance and anti-corruption and the need to have consumer awareness among the students. Dr. Anila Rose, HOD/S&H introduced the Resource Person Adv. Sahila Kumari of Nagercoil District Court, who deals with civil, criminal and consumer cases. She delivered a speech on consumer awareness and the importance of vigilance and anti-corruption in a democratic country like ours. She touched the topic of human rights and domestic violence too in her address. Then, the program was followed with an interacting session.

The students eagerly participated in the interaction, frankly, raised so many questions and the resource Person clarified all their doubts with the real examples she faced in her career. The Convener of the program Dr. Golding Sheeba AP/Physics proposed the vote of thanks, and the program came to an end with our National Anthem. All the first-year students and the members of the staff participated in this program and the students felt that it was very useful to them.

PRINCIPAL
ANNAI VAILANKANNI COLLEGE OF ENGINEERING
POTTALKULAM
AZHAGAPPAPURAM - 629 401
KANYAKUMARI DIST.



**ANNA VAILANKANNI
COLLEGE OF ENGINEERING**
Approved by AICTE, New Delhi & Affiliated to Anna University Chennai
Recognized under section 2(F) of UGC Act, 1956
Permanent Affiliation for B.E. - Computer Science and Engineering

**LEGAL AWARENESS PROGRAM
FRESHERS 2021**
Oct 29th



Adv. Shahila Kumari
Advocate Madhavadi District Court - Civil, Crim & Consumer cases
Public Prosecutor of Madhavadi Court
Kanyakumari District

Organised by
Department of Science & Humanities

Prof. Shajula Lindsey
Department of Chemistry

Prof. Gobling Sheela
Department of Physics

Dr. Anila
Head of the Department



COORDINATOR

HOD

PRINCIPAL

PRINCIPAL
ANNA VAILANKANNI COLLEGE OF ENGINEERING
POTTALKUDAW
AZHAGAPPAPURAM - 629 401
KANYAKUMARI DIST.



ANNAI VAILANKANNI
College of Engineering

REPORT

On



“ONE DAY AWARENESS AND QUIZ SESSION ON
GATE AND GOVERNMENT OPPORTUNITIES”

conducted on

12/01/2022

Entrepreneurship Development Cell

Report on Webinar in the topic “Placement and Entrepreneurship

Opportunities” on 12th January 2022

On 12th January 2022, the webinar was conducted in the topic, "Placement and Entrepreneurship Opportunities" through Unacademy AppLive telecast. The event was sponsored by Tamil Nadu government Entrepreneurship Development & Innovation Institute (EDII-TN) through Academic Innovation and Entrepreneurship Development Programme.

Date: 12-01-2022

Time: 2.p.m to 3.p.m

Meetinglink:<https://unacademy.com/course/placement-and-entrepreneurship-opportunities/9G94YJ5J>

Access code: VIVEKGATE20

Participants: All AVCE students

Mr. Vivekanandan discussed the ideas and prospects available to an entrepreneur in this webinar. He also discussed how to turn ideas into businesses and how to fund them through government and private programmes. The presentation concludes with an overview of the topic and its future applications. A total of 100 students took part in the webinar. Mrs. V.S. Jiji, Assistant Professor and Co-Coordinator of the Entrepreneurship Development Cell, coordinated the event.



PRINCIPAL
ANNAI VAILANKANNI COLLEGE OF ENGINEERING
POTTALKULAM
AZHAGAPPAPURAM - 629 401
KANNIYAKUMARI DIST.



ANNAI VAILANKANNI
College of Engineering
 Training and Placement Cell

Date: 12.01.2022
 Time: 02:00 PIA

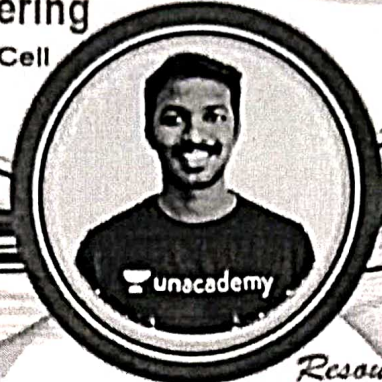

Proudly presents,

Webinar on

**"Awareness and Quiz Session on GATE
 and Government Job Opportunities"**

Resource Person:
Mr. R. Vivekanandan
 GATE educator,
 UNacademy

www.avce.edu.in

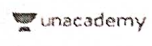
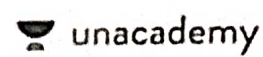

82 LIVE

Adityan.v... joined

D Jeevitha joined

Karthika joined

Maria joined

Blessingta... joined

You can now talk to the educator by raising your hand in the class

Jiji joined

Nithya joined

Jensi joined

Supriya joined

Muti... joined

Comment ? 🗨️ 😊

[Signature]
PRINCIPAL
 ANNAI VAILANKANNI COLLEGE OF ENGINEERING
 POTTAIKULAM
 AZHAGAPPAPURAM - 629 401
 KANTANUR DIST.

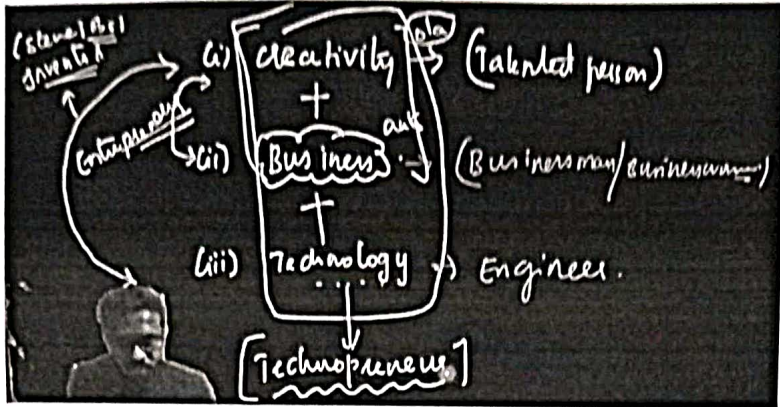

Kavitha joined

Jiji joined

Nithya joined

Jensi joined

Supriya joined

You can now talk to the educator by raising your hand in the class

Sp joined

Antony joined

Sureshroja joined

Subathra joined

Prishu joined

Comment

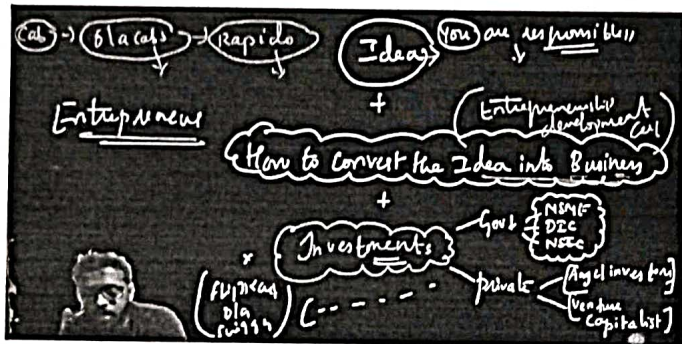

Jerisha joined

Kavitha joined

Jiji joined

Nithya joined

Jensi joined

You can now talk to the educator by raising your hand in the class

Vivekanandhan joined

Sp joined

Antony joined

Sureshroja joined

Subathra joined

Comment

Asel
PRINCIPAL
 ANNAI VAILANKANNI COLLEGE OF ENGINEERING
 POTTALKULAM
 AZHAGAPPAPURAM - 629 401
 KANTARUNARI DIST.

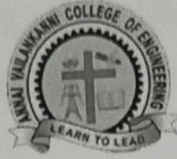

ANNAI VAILANKANNI
College of Engineering

REPORT

On

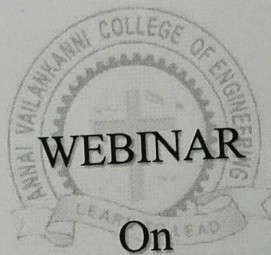

On

Topic

“Placement and Entrepreneurship Opportunities”

conducted on

5/02/2022

Entrepreneurship Development Cell

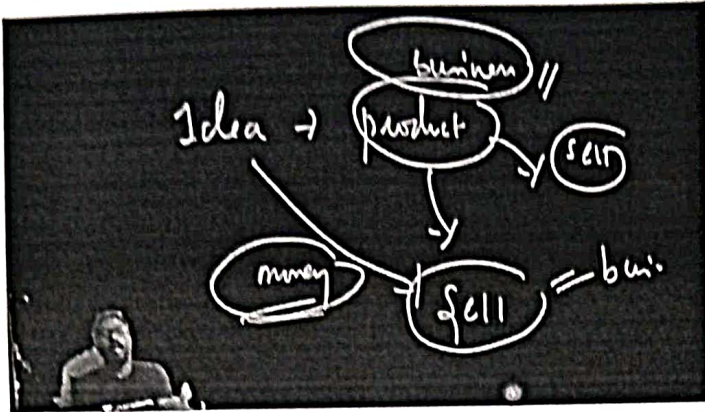

- Adityan v... joined
- D Jeevitha joined
- Karthika joined
- Marla joined
- Blessingta... joined
- You can now talk to the educator by raising your hand in the class
- Jiji joined
- Nithya joined
- Jensl joined
- Supriya joined
- Mut... ned

Comment ?

I hereby submit the report for your kind perusal.

Thank you,

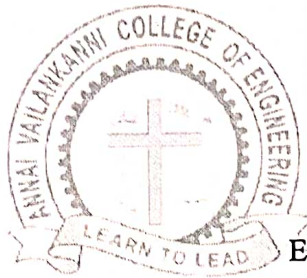

Prof. Lalu Gladson Robin,
Coordinator,
Entrepreneurship Development Cell,
Annai Vailankanni College of Engineering.

PRINCIPAL
ANNAI VAILANKANNI COLLEGE OF ENGINEERING
POTTALKULAM
AZHAGAPPAPURAM 629 401
KANYAKUMARI DIST.

CAREER COUNSELLING



**ANNAI VAILANKANNI
College of Engineering**

REPORT

On

AWARENESS PROGRAMME

On

“One Million Ideas”

Topic

“Be a transformational leader, become an entrepreneur

- Amazing ideas await you”

conducted on

12/10/2021

Entrepreneurship Development Cell

Report on Awareness programme on “One Million Ideas” in the topic “Be a transformational leader, become an entrepreneur - Amazing ideas await you” on

12th October 2021

On 12th October 2021, awareness programme was conducted in the topic, “Be a transformational leader, become an entrepreneur – Amazing ideas await you” at our college campus. The awareness programme on “ONE MILLION IDEAS” was originated from the Tamil Nadu government Entrepreneurship Development & Innovation Institute (EDII-TN) through Academic Innovation and Entrepreneurship Development Programme.

Following promotional poster was designed and circulated in the social media and in the student WhatsApp groups. And the same was kept as the backdrop at the BOSCH training room.

Entrepreneurship DEVELOPMENT & INNOVATION INSTITUTE

ANNAI VAILANKANNI College of Engineering

ACADEMIC INNOVATION AND ENTREPRENEURSHIP DEVELOPMENT PROGRAMME

Proudly presents
AWARENESS PROGRAMME
on
“ONE MILLION IDEAS”

Chief Guest: Er. Dheebin
Founder & MD, Kumari Shoppy

Venue
BOSCH Training Room

Date & Time
12/10/2021
9:50 am

Topic
**“Be a transformational leader,
become an entrepreneur
- amazing ideas await you.”**

Entrepreneurship Development Cell

Image 1: Promotional poster for the awareness programme.

PRINCIPAL
ANNAI VAILANKANNI COLLEGE OF ENGINEERING
POTTALKULAM
AZHAGAPPAPURAM 629 401
KANYAKUMARI DIST.

Er. Dheebin, Founder & MD of Kumari Shopy, was invited to the programme as a resource person. He was a 24-year-old young entrepreneur who founded his e-commerce company Kumari Shopy during his final semester of studies on February 14th, 2019. It has inspired our students to pursue their dreams of becoming entrepreneurs.

The following is a welcome poster that was designed and is displayed at the college's front portico to greet our visitors. The guests were greeted warmly and then led to the Principal's office for high tea and discussion. Following a brief discussion, the guests were directed to the BOSCH training room to start the awareness programme.

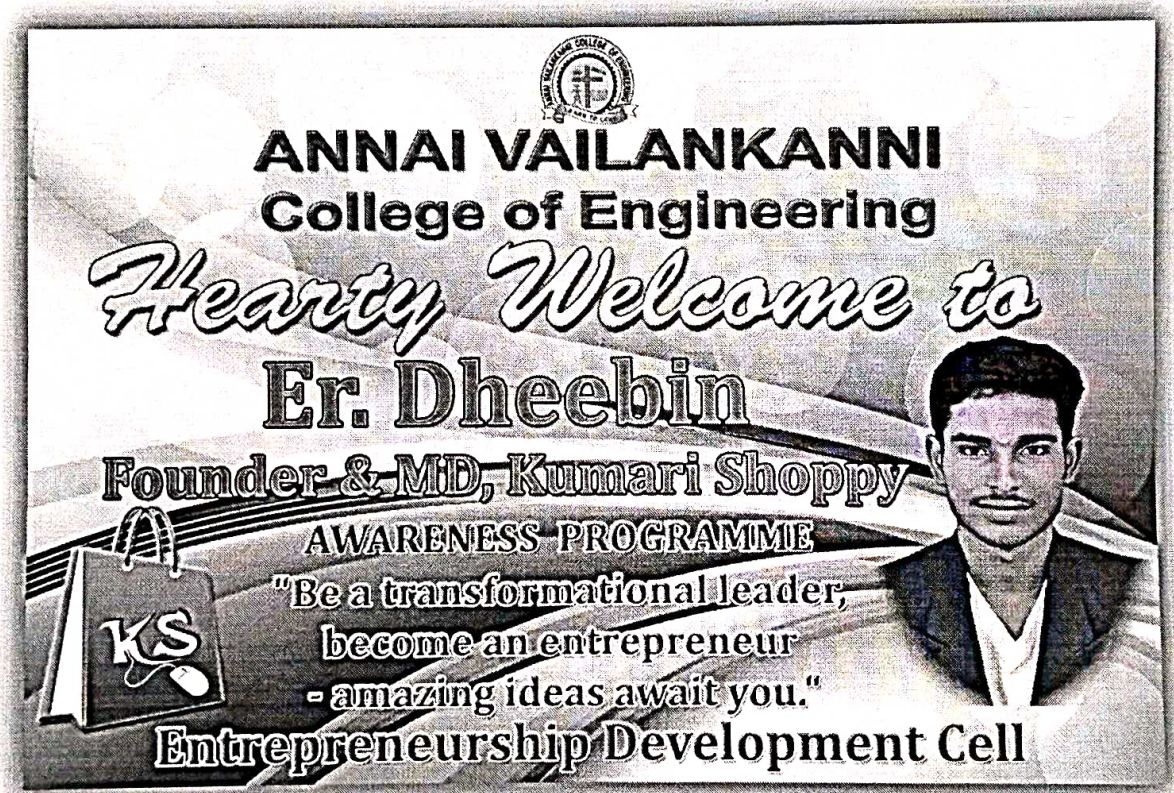



Image 2: Welcome poster

PRINCIPAL
ANNAI VAILANKANNI COLLEGE OF ENGINEERING
POTTALKULAM
AZHAGAPPAPURAM - 629 401
KANTAKUMARI DIST.

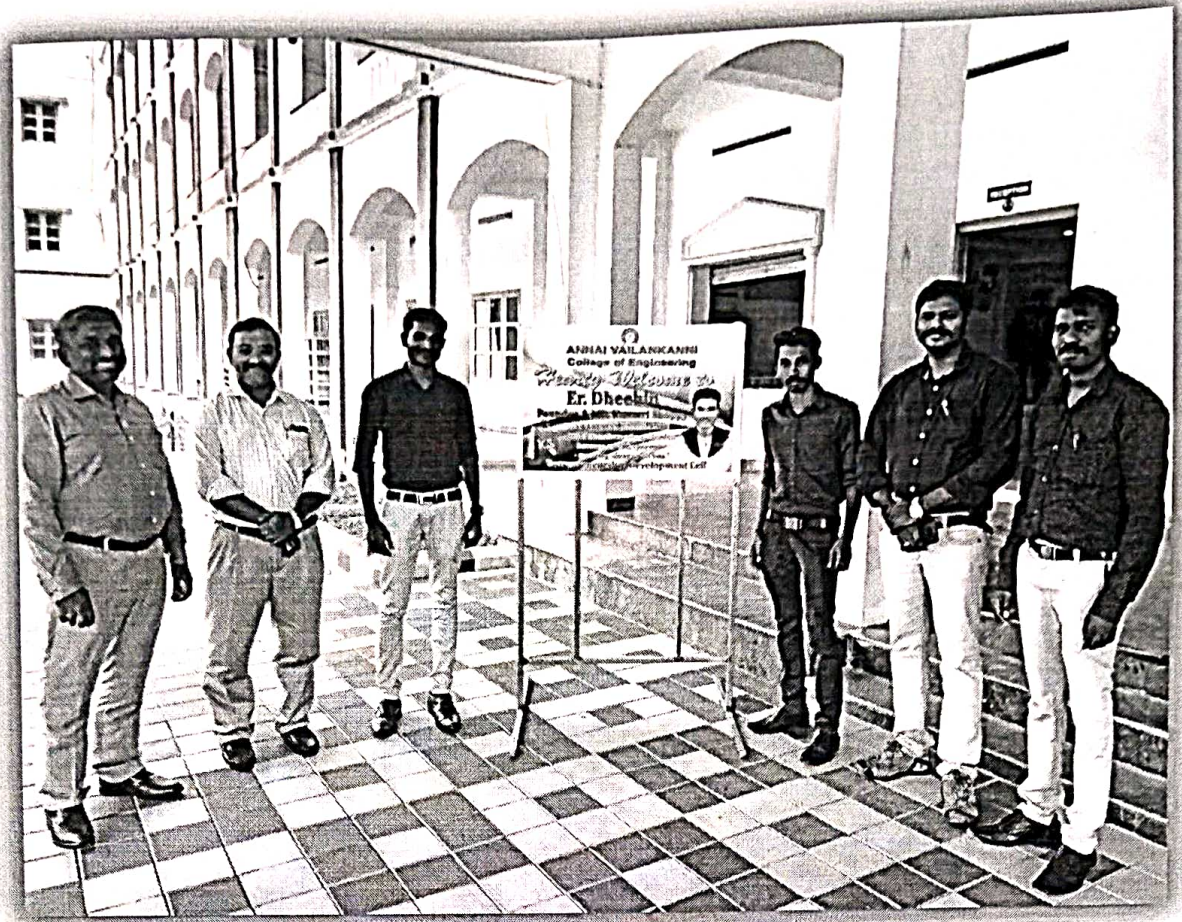

Image 3: Warm welcome to the resource person Er. Dheebin.

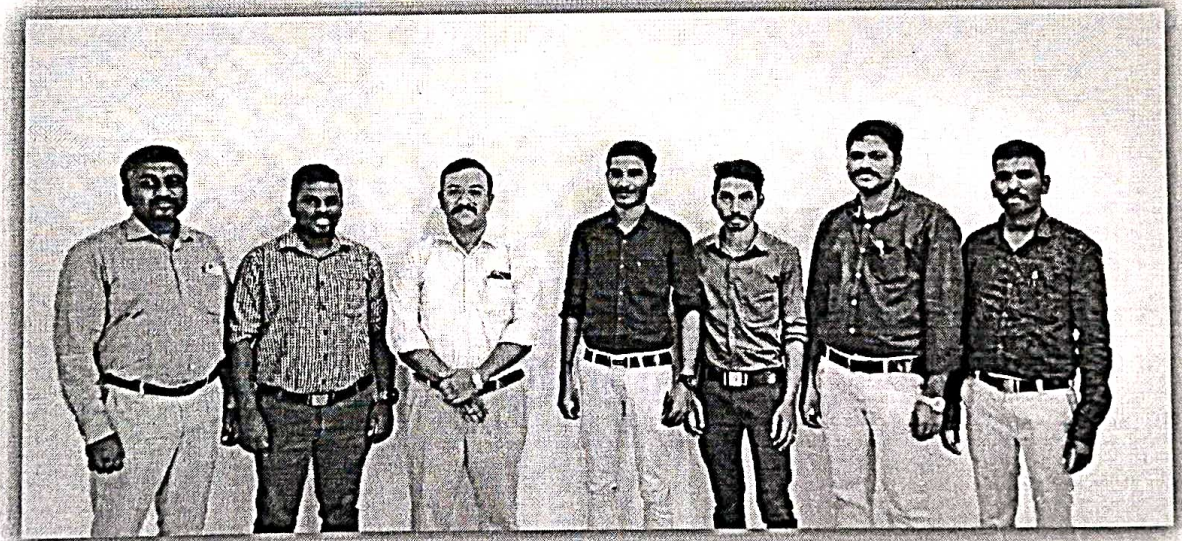
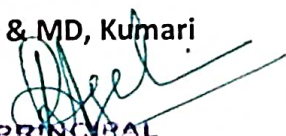

Image 4: Discussion at the Principal's room with Er. Dheebin (Founder & MD, Kumari Shoppo) and Mr. Abish (Director, Kumari Shoppo).

PRINCIPAL
ANNAI VAILANKANNI COLLEGE OF ENGINEERING
POTTALKULAM
AZHAGAPPAPURAM 629 401
KANYAKUMARI DIST.

Following was the programme schedule

9:50 am	Silent Prayer	:
9:52 am	Welcome Address	: Prof. Lalu Gladson Robin, Head, Entrepreneurship Development Cell
9:55 am	Principal Address	: Dr. A. Benham, Principal
10:00 am	Chief Guest Introduction	: Prof. Robert, Coordinator, Entrepreneurship Development Cell
10:02 am	Chief Guest Address	: Er. Dheebin, Founder & MD, Kumari Shoppy
10:30 am	Student Feedback	:
10:35 am	Vote of Thanks	: Dr. J. Sunil, Dean (Research) and HoD Mechanical

The event began with a silent prayer. Lalu Gladson Robin welcomed everyone to the awareness programme. Dr. A. Benham delivered the principal's address, in which he explained the distinction between an entrepreneur and a businessman. Prof. Robert introduced the resource person to the audience. Er. Dheebin expresses his thoughts and inspired the audience with his maiden debut in front of college students, emphasising the idea of "Never Give Up." He also emphasised the importance of lifelong learning, as well as .

PRINCIPAL
 ANNAL VAILANKANNI COLLEGE OF ENGINEERING
 POTTALKULAM
 AZHAGAPPAPURAM 629 401
 KANNIYAKUMARI DIST.

taking risks and recommending that students try rather than stay idle. The programme drew a total of 60 final-year students. During the student feedback session, Mr. Arun Rakesh, a final-year Mechanical Engineering student, provided brief feedback on the programme. Dr. J. Sunil then delivered the vote of thanks.

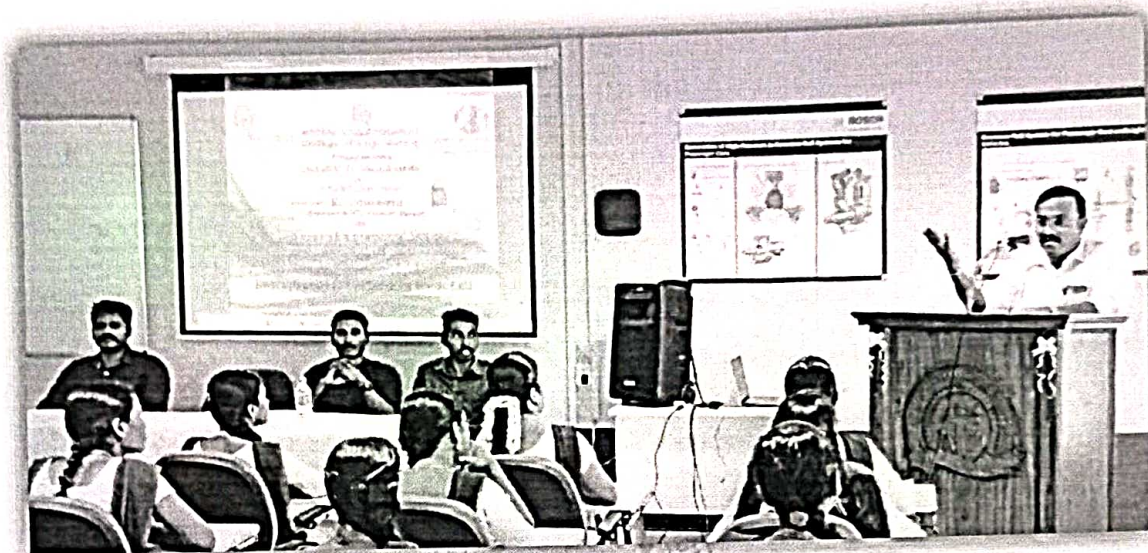

Image 5: Principal's Address.

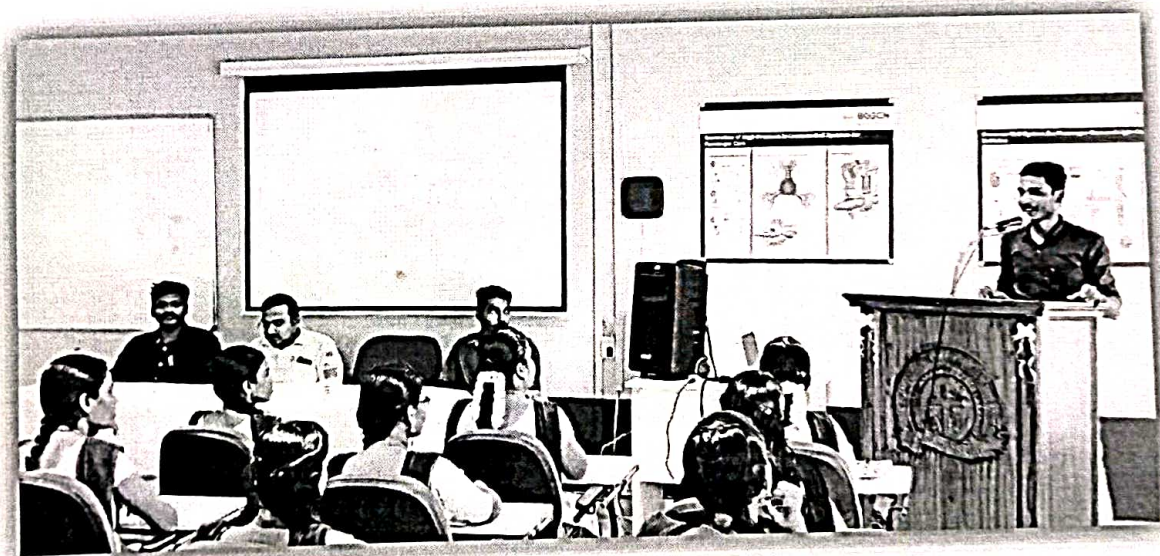

Image 6: Address by Er. Dheebin, Founder and MD, Kumari Shoppo a e-Commerce company.

[Signature]
PRINCIPAL
ANNAI VAILANKANNI COLLEGE OF ENGINEERING
POTTALKULAM
AZHAGAPPAPURAM - 629 401
KANTAKUMARI DIST.

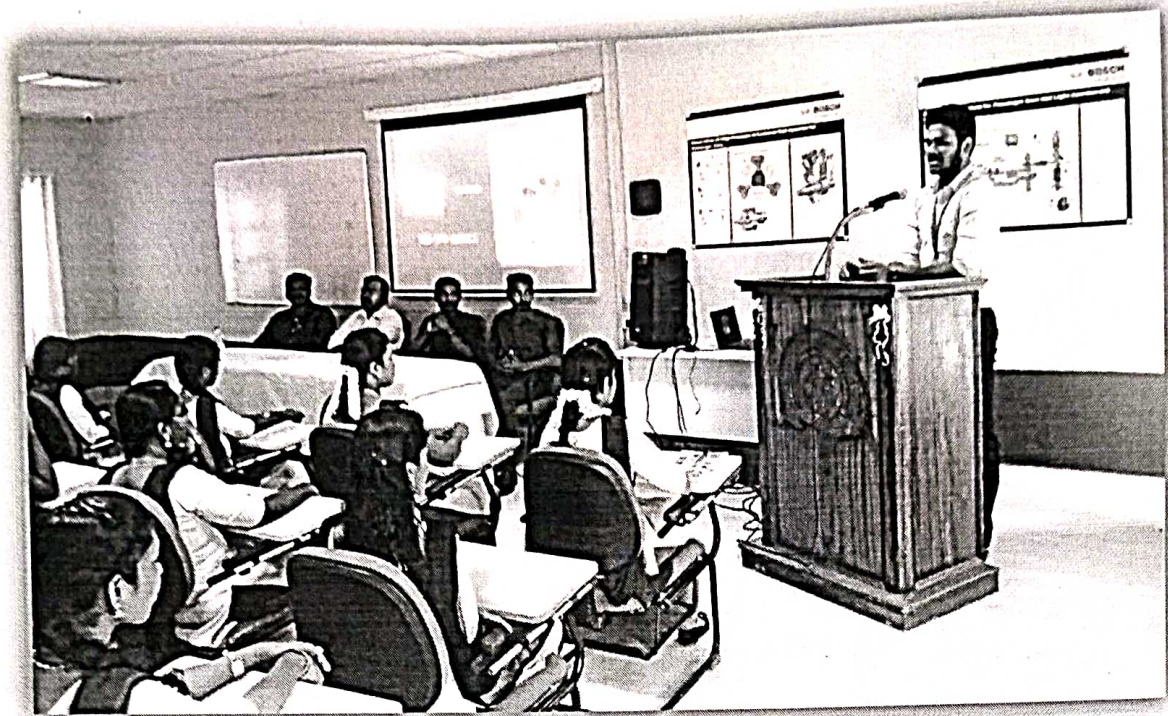

Image 7: Feedback session.



Image 8: Student feedback about the programme by Mr. Arun Rakesh, final year mechanical engineering.



PRINCIPAL
ANNAI VAILANKANNI COLLEGE OF ENGINEERING
POTTALKULAM
AZHAGAPPAPURAM - 629 401
KANYAKUMARI DIST.



Image 9: Vote of thanks by Dr. J. Sunil, Dean (Research) and HoD Mechanical Engineering.

Following the student feedback session, floor nominations were made to select a male and female candidate for the position of e-leader. Mr. Antony Kishore of final year Mechanical Engineering and Ms. Subathra of final year Electronics and Communication Engineering were proposed by students. They were both elected unanimously.

Furthermore, students were instructed to register in the EDII-TN portal <https://www.editn.in/Entrepreneurs/register> to take the online awareness course and submit the e-certificate to the Entrepreneurship Development Cell.

I hereby submit the report for your kind perusal.

Thank you,

Prof. Lalu Gladson Robin,
Head,
Entrepreneurship Development Cell,
Annai Vailankanni College of Engineering.

PRINCIPAL
ANNAI VAILANKANNI COLLEGE OF ENGINEERING
POTTALKULAM
AZHAGAPPAPURAM - 623 401
KANNIYAKUMARI DIST.



ANNAI VAILANKANNI

College of Engineering

REPORT

On

Awareness Programme

On

Topic

“Business Plan Preparation Workshop”

conducted on

11/02/2022

Entrepreneurship Development Cell

Report on Awareness programme in the topic "Business Plan Preparation

Workshop" on 11th February 2022

On 11th February 2022, workshop was conducted in the topic, "Business Plan Preparation Workshop" at our college auditorium. The event was sponsored by Tamil Nadu government Entrepreneurship Development & Innovation Institute (EDII-TN) through Academic Innovation and Entrepreneurship Development Programme.

The chief guest and resource person for the exclusive workshop on "Business Plan Preparation" was Er. Dheebin, Founder & MD, Kumari Shoppo. He encouraged and motivated students to pursue a career as an entrepreneur while still in college. He also testified about his own firm and described the challenges he faced.

Entrepreneurship
DEVELOPMENT & INNOVATION INSTITUTE

ANNAI VAILANKANNI
College of Engineering

ACADEMIC INNOVATION AND
ENTREPRENEURSHIP
DEVELOPMENT PROGRAMME

Proudly presents
AWARENESS PROGRAMME
on
"ONE MILLION IDEAS"

Chief Guest: **Er. Dheebin**
Founder & MD, Kumari Shoppo

Venue
Auditorium

Date & Time
11/02/2022
2:00 pm

Topic
"Business Plan
Preparation Workshop"

Entrepreneurship Development Cell
www.avce.edu.in

PRINCIPAL
ANNAI VAILANKANNI COLLEGE OF ENGINEERING
POTTALKULAM
AZHAGAPPAPURAM - 629 401
KANYAKUMARI DIST.



ANNAI VAILANKANNI
College of Engineering

Hearty Welcome to

Er. Dheebin

Founder & MD, Kumari Shoppy

AWARENESS PROGRAMME

"Business Plan

Preparation Workshop"

Entrepreneurship Development Cell



PRINCIPAL
ANNAI VAILANKANNI COLLEGE OF ENGINEERING
POTTALKULAM
AZHAGAPPAPURAM - 629 401
KANYAKUMARI DIST.



ANNAI VAILANKANNI College of Engineering

ACADEMIC INNOVATION AND
ENTREPRENEURSHIP

AWARENESS PROGRAMME On "One Million Ideas"

"Business Plan Preparation Workshop"

Minute – to – Minute Programme Schedule



2:00 pm	Silent Prayer	
2:02 pm	Welcome Address	: Prof. Bharathi, Assistant Professor, S&H Department
2:05 pm	Principal Address	: Dr. A. Benham, Principal
02:10 pm	Chief Guest Introduction	: Prof. R. Robert, Co-Coordinator, Entrepreneurship Development Cell
2:12 pm	Chief Guest Address	: Er. Dheebin, Founder & MD, Kumari Shopy
2:50 pm	Student Feedback	:
2:55 pm	Vote of Thanks	: Dr. M.R. Anila Rose, HOD S&H





PRINCIPAL

ANNAI VAILANKANNI COLLEGE OF ENGINEERING
POTTALKULAM
AZHAGAPPAPURAM - 629 401
KANYAKUMARI DIST.

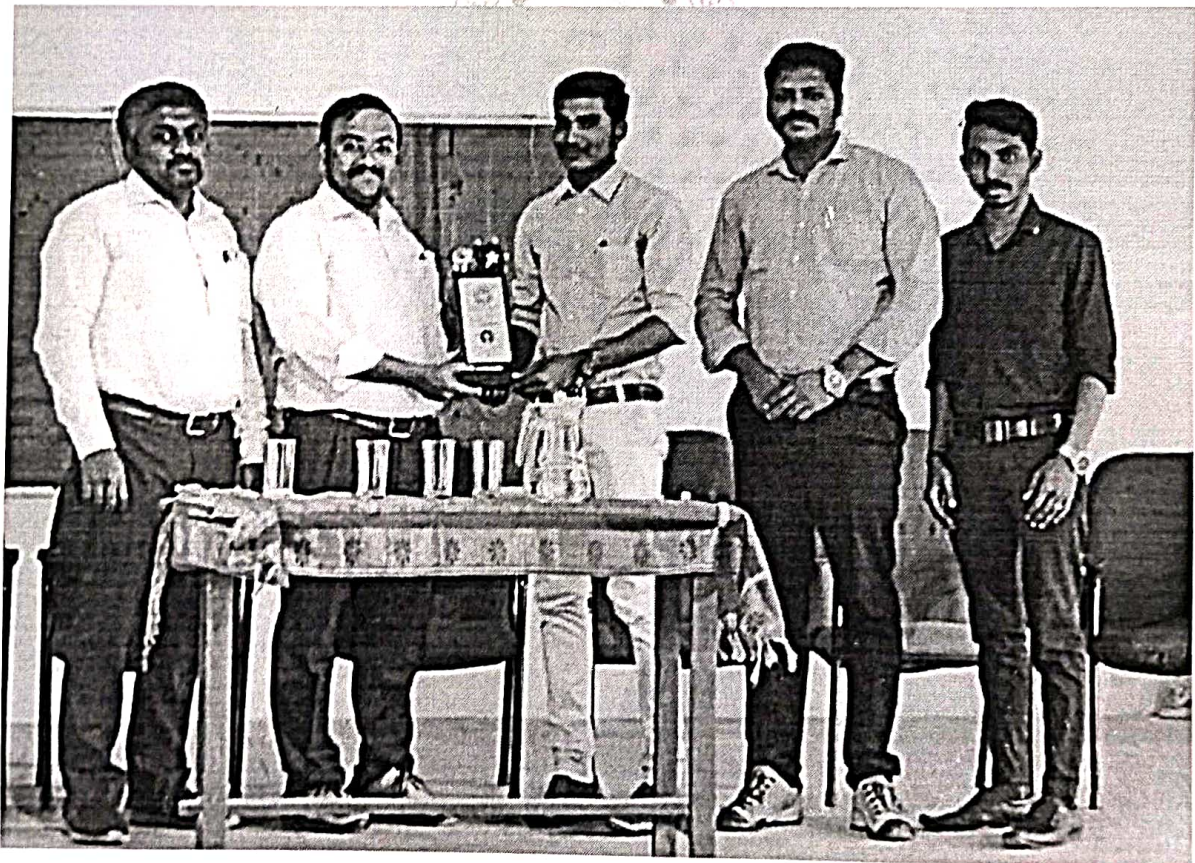
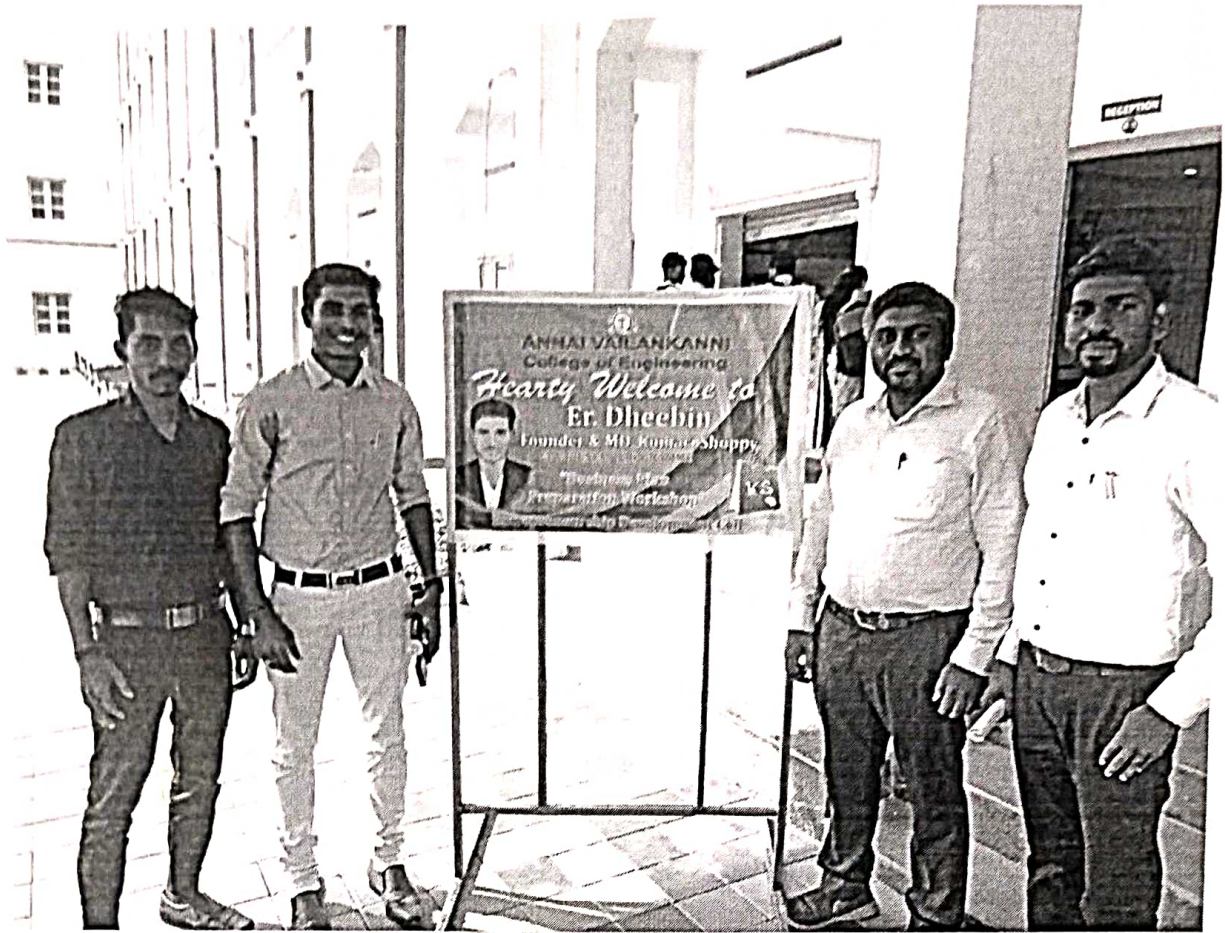

PRINCIPAL
ANNAI VAILANKANNI COLLEGE OF ENGINEERING
POTTALKULAM
AZHAGAPPURAM - 629 401
KANYAKUMARI DIST.



PRINCIPAL
ANNAI VAILANKANNI COLLEGE OF ENGINEERING
POTTALKULAM
AZHAGAPPAPURAM - 629 401
KANTAKUMARI DIST.

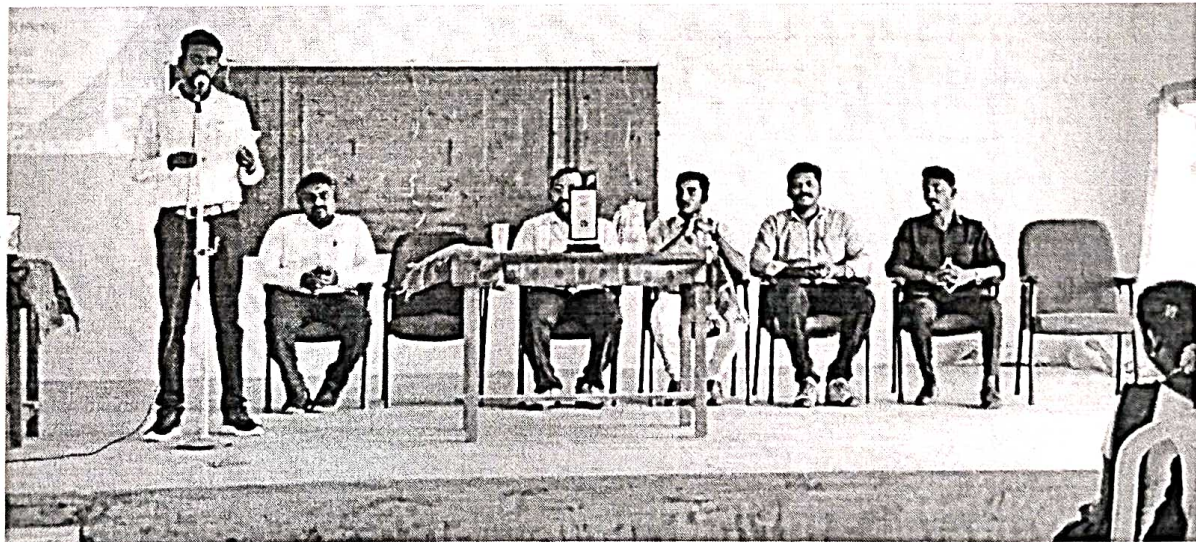
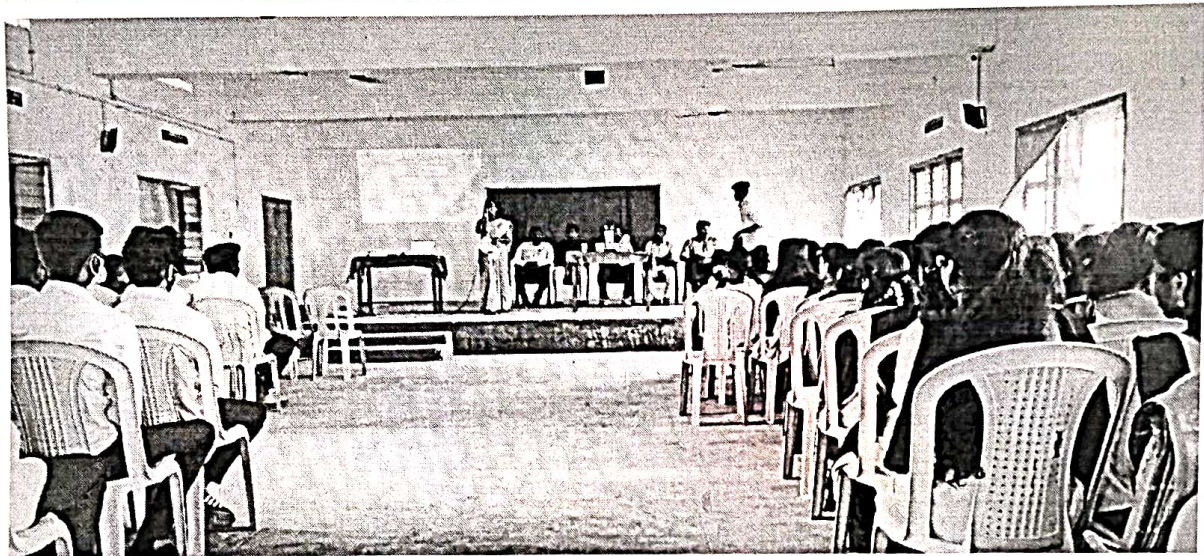
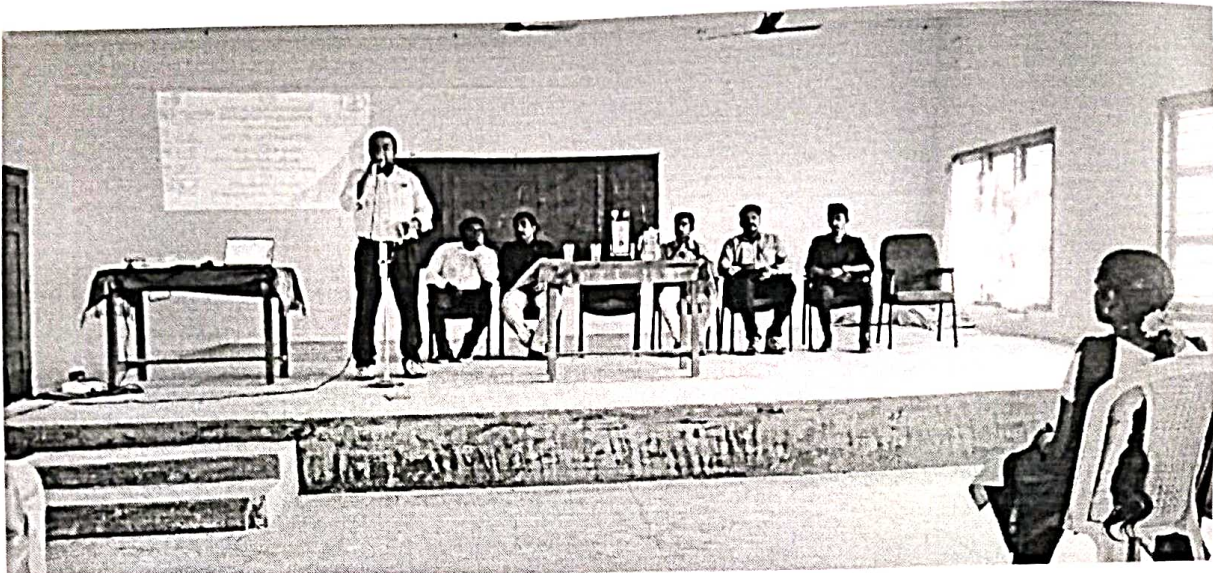

Mr. Robert, Assistant Professor and Co-Coordinator of the Entrepreneurship Development Cell, coordinated the event.



PRINCIPAL
ANNAI VAILANKANNI COLLEGE OF ENGINEERING
POTTALKULAM
AZHAGAPPAPURAM - 629 401
KANTAKUMARI DIST.

Following is the list of participants.

SL.NO	NAME
1	PRIYANKA.J
2	JESHIKA.S
3	MONISHA .M
4	RAGUL R
5	ASHA
6	KAVIYA
7	ANTO SAHAYA JAIWIN.A
8	ANISH. M
9	R.T.MONIKA
10	ASHIKA M
11	RACHEL.D
12	A.PAVITHRA
13	SELVA THARUN R R
14	SRITHAR
15	A.MARIAMMAL
16	SHEKA G
17	K. MUGUNTHAN MANO
18	A.VINOTH KUMAR
19	N.MINI
20	K.SHANTHINI
21	ADITYAN V L
22	R V DERVIN
23	S.PRIYANKA
24	A.S.PONSELVI
25	SELVA PRIYA J
26	SAM.J.DUFORT
27	JEROME S DOMINIC
28	SWETHA
29	M.ANITHA
30	M. DHARSHINI
31	D.BHARADWAJ
32	SHARMI.J
33	C. SAJITHA
34	L.K.SHAMILI
35	PAVITHRA.K
36	KAVASKER
37	THAMEEMALHUSSAIN
38	N. LIBINESH
39	M.ASUWATHI
40	A. MANIMURUGESWARAN
41	M.DEEPAK
42	R. DINESH
43	E BEBIN RAJ
44	A.ANISHA
45	JENIFER

PRINCIPAL
 ANNAI VAILANKANNI COLLEGE OF ENGINEERING
 POTTALKULAM
 AZHAGAPPAPURAM - 629 401
 KANTHAKUMARI DIST.

46	E BEBIN RAJ
47	S.S.ABIJITH
48	ANISH.S
49	A.CATHERIN ROFICA
50	SNOJA
51	KEEBO A.L
52	D.RAVEEN
53	NISHA NANTHINI M.S.
54	A ABISHEK
55	HARRIS.R
56	V.MARIAPPAN
57	M BRITTO SOLOMON
58	DIVYA.M
59	PAVITHRA.P
60	M. RAMAKRISHNAN
61	M.KANNIKA
62	BAVI.K
63	JOTHI
64	N.SNEHA
65	S.RAJA
66	L.JINISHA
67	JEGATHEESH
68	PRAKASH S
69	HARISH MAN.S
70	DEVI.S
71	ANNIES RAVIN R
72	S.SUBITHA
73	I. JOHNSON JEBASEELAN
74	ABINESH.R
75	KINGSHERIN
76	SHIJO. D
77	S.ANUSHA
78	M.NOUFAL
79	ANU DHARSHINI N
80	JOSELIN SHIJO
81	K. BAVITHIRA
82	DINESHKUMAR. K
83	NISHA. M
84	T. C. TINIS CHRISTAN JOE
85	S.ISHWARYA
86	BHARATH.S
87	ABINESH.R
88	SALINI.I
89	ANITHA M
90	NANTHINI S
91	KRISHNAN
92	SUBIN
93	M.SIVA AKASH
94	VISHWAHAR
95	B JUDWIN DINO
96	ADWIN RAJ R
97	HARISH KRISHNAN

PRINCIPAL
ANNAL VAILANKANNI COLLEGE OF ENGINEERING
POTTALKULAM
AZHAGAPPAPURAM - 629 401
KANYAKUMARI DIST.

98	JENITH J
99	JINO A
100	MICHAEL SUJIN X
101	NITHIN REHOBOTH SALAL
102	SUBITHA A
103	THANAMSEELAN C
104	VIJAY PRASAS VV
105	A ASHA
106	BELSI MARY S
107	J JEBIN
108	J SUBISHA
109	S MITHUNA
110	LIJU.L
111	AKALYA. M
112	DHANESH
113	MABLE VIMALA S
114	N.AKILAN
115	JERISHA C
116	SARANYA.T
117	NANTHINI.NS
118	NAVEEN KUMAR S.
119	BABISHA M
120	R.THANA REKA
121	V. KAVITHA
122	A.NANTHINI
123	PONSEKAR. C
124	SANTHOSH.G
125	ABHISHEK O
126	ABIN T
127	AJESH Y
128	AMAL P
129	ANNA BABISHA T
130	ARTHUR GODSON C
131	BINIL MARX G.S
132	CHANDRALEKA S
133	HELAN MARY E
134	JELICK SUKIK S
135	JINO I
136	LATHA MALATHI P
137	MAHESH M
138	MARIYAPPAN G
139	MATHAN M
140	MICHAEL SINGARAYAR THOMSON S

PRINCIPAL
 ANNAL VAILANKANNI COLLEGE OF ENGINEERING
 POTTALMULAM
 AZHAGAPPAPURAM - 620 401
 KANTAKUMARI DIST.

141	MICHEAL THOMAS JEBA VALAN P
142	MOHINI N
143	NINISHA L
144	PRASANNA M
145	RAHUL HARI J
146	RAJA DONALD N
147	RAJESH KUMAR I
148	SANJAY T
149	SATHISH N S
150	SUPRIYA S
151	VARSHA S P
152	ALSIA JUDIT S
153	BALA SARAVANAN
154	REHJO MATHEW R





PRINCIPAL
ANNA VAILANKANNI COLLEGE OF ENGINEERING
POTTALKULAM
AZHAGAPPAPURAM - 629 401
KANYAKUMARI DIST.

I hereby submit the report for your kind perusal.

Thank you,



Prof. Lalu Gladson Robin,
Coordinator,
Entrepreneurship Development Cell,
Annai Vailankanni College of Engineering.



PRINCIPAL
ANNAI VAILANKANNI COLLEGE OF ENGINEERING
POTTALKULAM
AZHAGAPPAPURAM 629 401
KANTAKUMARI DIST.



ANNA VAILANKANNI
College of Engineering

REPORT

On

Awareness Programme

On

Topic

“IPR”

conducted on

18/02/2022



Entrepreneurship Development Cell

Report on Awareness programme in the topic "IPR" on 18th February 2022

On 18th February 2022, webinar was conducted in the topic, "IPR" at our college auditorium. The event was sponsored by Tamil Nadu government Entrepreneurship Development & Innovation Institute (EDII-TN) through Academic Innovation and Entrepreneurship Development Programme.

Webex link: <https://chennai-patent.webex.com/j.php?MTID=ma76e21c1156c18a2ecdc9fbf8016672c>

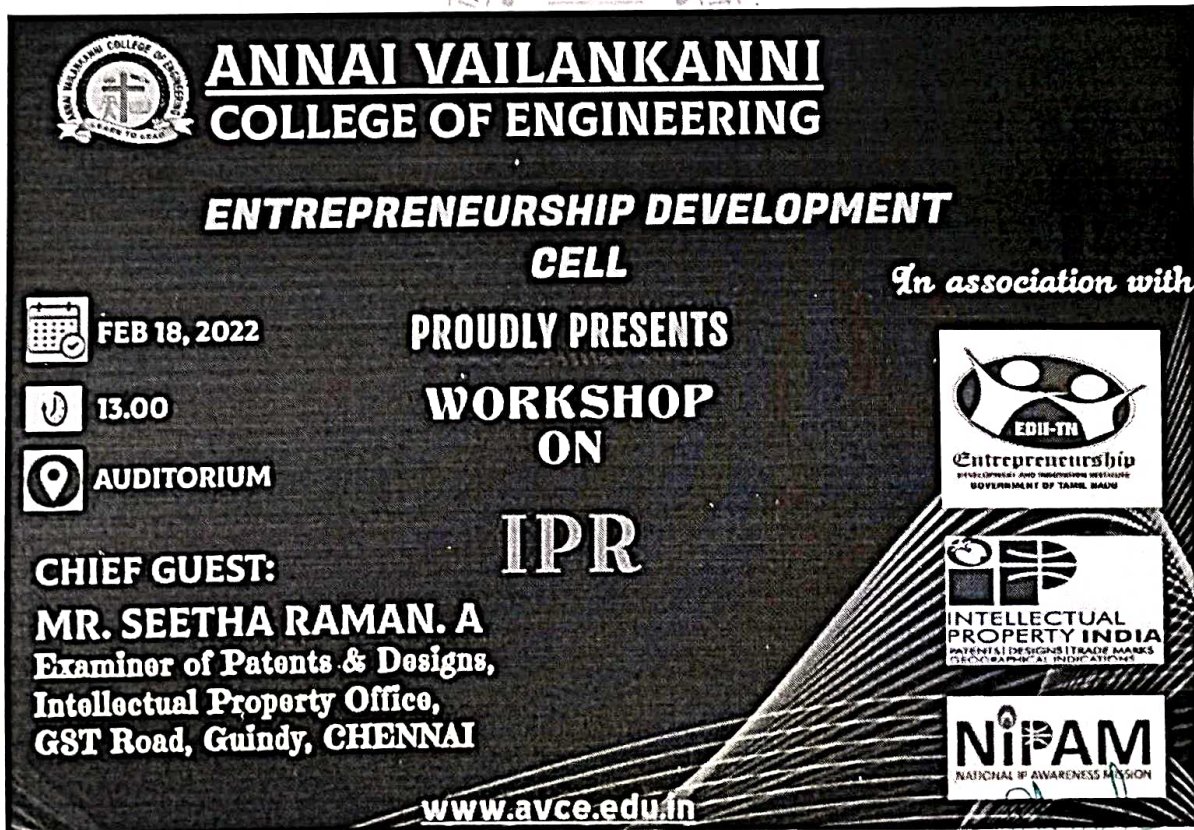
Mr. Seetha Raman, Examiner of Patents & Designs, Intellectual Property Office, GST Road, Guindy, Chennai, presented a lecture to the students who were present both online and in person utilizing the Webex platform. He described numerous Intellectual Property Rights (IPRs) and presented an overview of IPRs starting from the beginning for a better understanding.



**ANNAI VAILANKANNI
COLLEGE OF ENGINEERING**

**ENTREPRENEURSHIP DEVELOPMENT
CELL**

In association with

**PROUDLY PRESENTS
WORKSHOP
ON
IPR**

**CHIEF GUEST:
MR. SEETHA RAMAN. A
Examiner of Patents & Designs,
Intellectual Property Office,
GST Road, Guindy, CHENNAI**

FEB 18, 2022

13.00

AUDITORIUM

**EDII-TN
Entrepreneurship
DEVELOPMENT AND INNOVATION INSTITUTE
GOVERNMENT OF TAMIL NADU**

**INTELLECTUAL
PROPERTY INDIA
PATENTS | DESIGNS | TRADE MARKS
TECHNOLOGICAL INDICATIONS**

**NIPAM
NATIONAL IP AWARENESS MISSION**

www.avce.edu.in

PRINCIPAL
ANNAI VAILANKANNI COLLEGE OF ENGINEERING
POTTALKULAM
AZHAGAPPAPURAM - 629 401
KANYAKUMARI DIST.



ANNAI VAILANKANNI College of Engineering

ACADEMIC INNOVATION AND
ENTREPRENEURSHIP

AWARENESS PROGRAMME

On

"IPR"

Minute – to – Minute Programme Schedule



1:00 pm Silent Prayer

1:02 pm Welcome Address

: ~~Ms. Subashree~~ IV ECE
E Leader, Entrepreneurship Development Cell

01:10 pm Chief Guest Introduction

: ~~Mr. D. Raveen~~,
IAI&DS

1:12 pm Chief Guest Address

: Mr. Seetha Raman. A.,
Examiner of Patents & Designs,
Intellectual Property Office,
GST Road, Guindy,
Chennai.

1:50 pm Student Feedback

:

1:55 pm Vote of Thanks

: ~~Ms. Menika~~,
ICSE

PRINCIPAL
ANNAI VAILANKANNI COLLEGE OF ENGINEERING
POTTALKULAM
AZHAGAPPAPURAM - 629 401
KANTANUMARI DIST.



**NATIONAL INTELLECTUAL
PROPERTY AWARENESS
MISSION (NIPAM)**

PRINCIPAL
ANNAL VAILANKANNI COLLEGE OF ENGINEERING
POTTALAKULAM
AZHAGAPPAPURAM - 629 401
KANYAKUMARI DIST.

OUTLINE

- IPR - Understanding
- Various IPRs
- Q & A
- Quiz



PRINCIPAL
ANNAI VAILANKANNI COLLEGE OF ENGINEERING
POTTALKULAM
AZHAGAPAPURAM - 629 401
KANNIYAKUMARI DIST.

WHAT'S INTELLECTUAL PROPERTY (IP)?

Intellectual property (IP) is a property that arises from *human intellect*. It is a product of human creation.

• IP is "Creative ideas & expressions of human mind (intellect)"

Examples:

- Project
- Poem/Lyrics
- Story
- Drawing
- Photography
- Design
- Logo/slogan
- Mobile app
- etc.

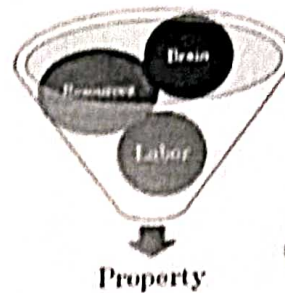

The \$500m smiley face business

Nearly 50 years ago, one man 'invented' the modern smiley face. Then, another man halfway across the world made it into a multimillion-dollar cash cow

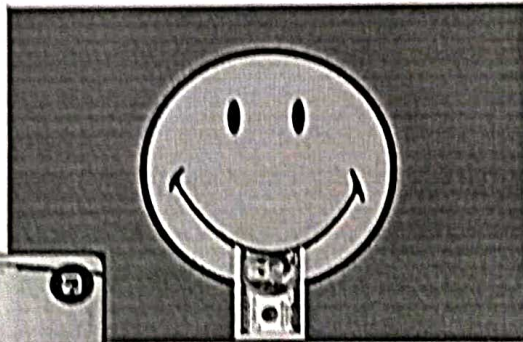

le.co/who-owns-the-smiley-face/

[Signature]
PRINCIPAL
ANNAI VAILANKANNI COLLEGE OF ENGINEERING
POTTALKULAM
AZHAGAPPAPURAM - 629 401
KANYAKUMARI DIST.

SHAPES OF BOTTLES



Disclaimer: Not an advertisement, representation for education purpose



[Signature]
PRINCIPAL
ANNAI VAILANKANNI COLLEGE OF ENGINEERING
POTTALKULAM
AZHAGAPURAM 629 401
KANTHAKUMARI DIST.

SUBJECT MATTER OF TRADEMARKS

- o Brand Name
- o Tagline (Slogans)
- o Sound Mark (Lion Roaring of MGM, Britannia)
- o Logo (combination of colours)

Slogans and Taglines



L'ORÉAL.



TRADE MARKS

- o A sign capable of distinguishing the goods services of one enterprise from those of other enterprises.



FedEx.

BLUE DART



PRINCIPAL

ANNAL VAILANKANNI COLLEGE OF ENGINEERING

POTTAI KULAM

AZHAKKOTTAIPURAM - 629 401







KANTANUR DIST.

BUNDLE OF RIGHTS

Reproduction Right	<ul style="list-style-type: none"> • Preventing others of making copies of your work • Right to reproduce work in material form
Distribution Right	<ul style="list-style-type: none"> • Dissemination of physical copies of work • Right of rental
Right to create derivative works	<ul style="list-style-type: none"> • Adaptations, translations, compilations • Cinema, sound recordings
Right of communication to public	<ul style="list-style-type: none"> • Relaying of work by distant or interactive communication means
Right of public performance	<ul style="list-style-type: none"> • Right to perform the work in public

22

TERM OF COPYRIGHT

					
Literary, Dramatic, Musical or Artistic Works	Anonymous & Pseudonymous Works	Works of Public Undertakings & Government Works	Works of International Organization	Sound Recording	Cinematograph Films
Life-time of the author and until 60 years from the death of the author	60 years from the year the work was first published	60 years from the year the work was first published	60 years from the year the work was first published	60 years from the year in which the recording was published	60 years from the year in which the film was published

23

Aseel
PRINCIPAL
 ANNAL VAILANKANNI COLLEGE OF ENGINEERING
 POTTALKULAM
 AZHAGAPPURAM - 629 401
 KANTANUMARI DIST.

189

SEMICONDUCTOR INTEGRATED CIRCUITS LAYOUT-DESIGN

- o A semiconductor layout design means a layout of transistors and other circuitry elements and include lead wires connecting such elements and expressed in any manner in semiconductor integrated circuits.
- o Original, Distinctive, Capable of being distinguishable from any other layout-design, and have not been commercially exploited anywhere else

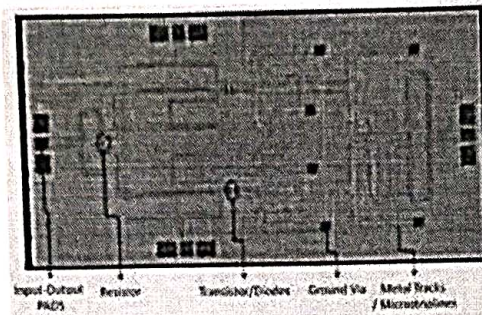

25

**SIRUMALAI HILL
BANANA**



**TEMPLE JEWELLERY
OF NAGERCOIL**

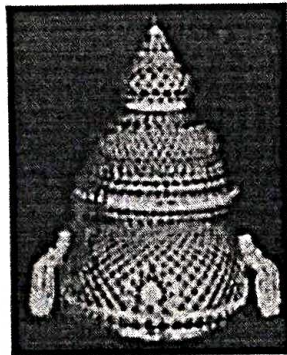

Foreign GI

1. France Champagne
2. France Cognac
3. United Kingdom Scotch Whiskey
4. Mexico Tequila
5. Irish Whiskey
6. Munchener Bier

29

[Signature]
PRINCIPAL
ANNAL VAILANKANNI COLLEGE OF ENGINEERING
POTTALKULAM
AZHAGAPPAPURAM - 629 401
RANTAKUMARI DIST.

- A trade secret is any practice or process of a company that is generally not known outside of the company. Information considered a trade secret gives the company an economic advantage over its competitors and is often a product of internal research and development.
- Agreement of confidentiality

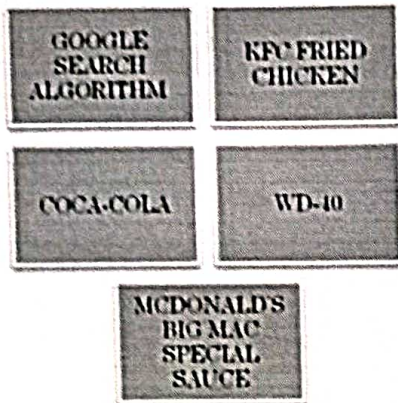

Google

31

WHAT IS PATENT

- PATENT IS A GRANT BY SOVEREIGN OR STATE TO A PERSON
- GIVING EXCLUSIVE RIGHT TO Stop others from "Making, Using, Offering for sale, Selling AND Importing"

AN INVENTION FOR A LIMITED PERIOD, IN EXCHANGE FOR DISCLOSING IT IN A PATENT SPECIFICATION *Such that any one trained in the art can reproduce the invention.*

- OWNER HAS A QUALIFIED RIGHT TO USE THE INVENTION

32

Appel
 PRINCIPAL
 ANNAI VAILANKANNI COLLEGE OF ENGINEERING
 POTTALKULAM
 AZHAGAPPURAM - 629 381
 KANTAKUMARI DIST.

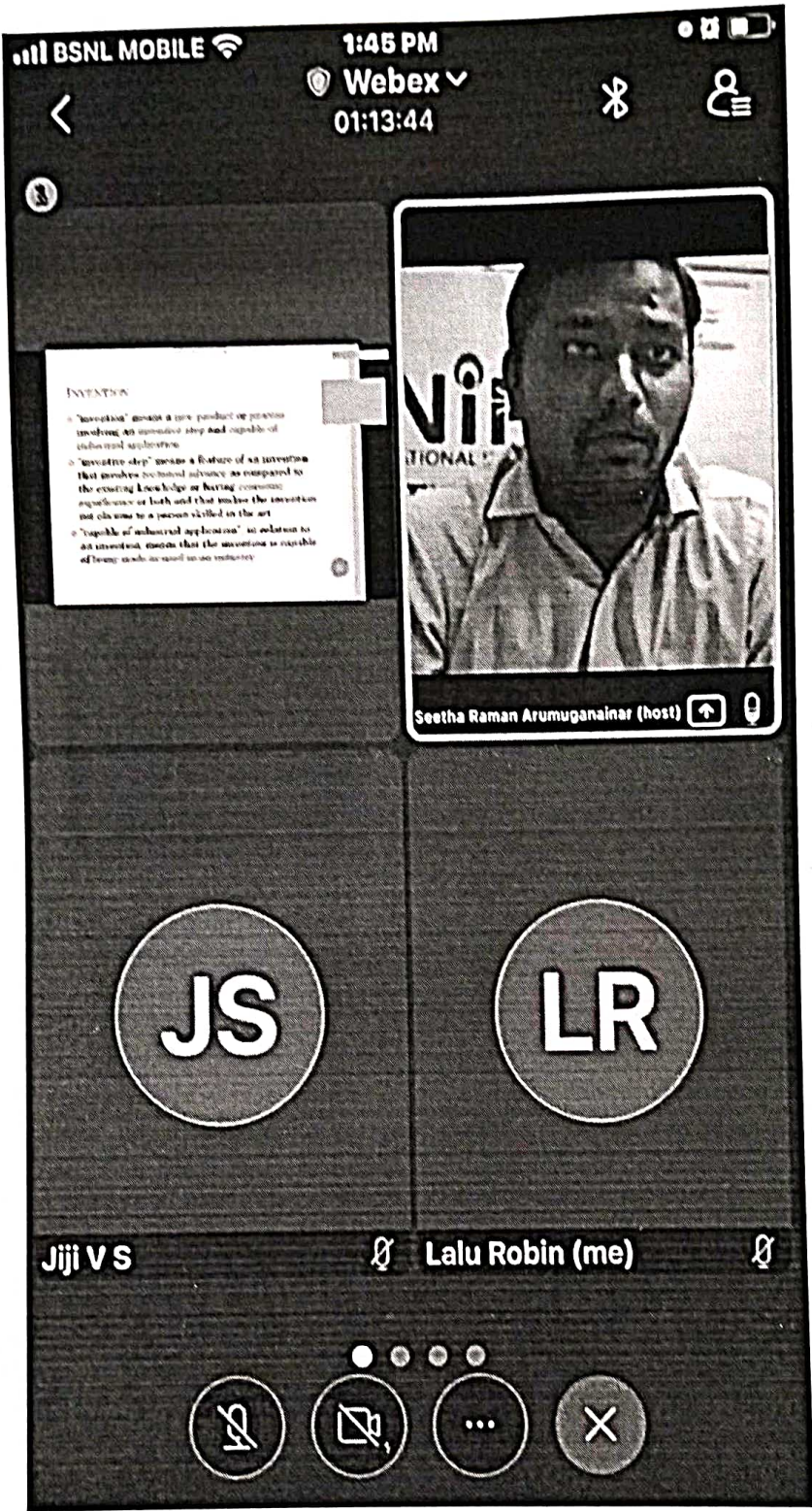

INVENTION

- "invention" means a new product or process involving an inventive step and capable of industrial application.
- "inventive step" means a feature of an invention that involves technical advance as compared to the existing knowledge or having economic significance at least and that makes the invention not obvious to a person skilled in the art.
- "capable of industrial application" in relation to an invention means that the invention is capable of being made or used in an industry.



Seetha Raman Arumuganainar (host)

JS

LR

Jiji VS

Lalu Robin (me)

Agel
PRINCIPAL
ANNAI VAILANKANNI COLLEGE OF ENGINEERING
POTTALKULAM
AZHAGAPPAPURAM - 629 401
KANYAKUMARI DIST.

US5255452A

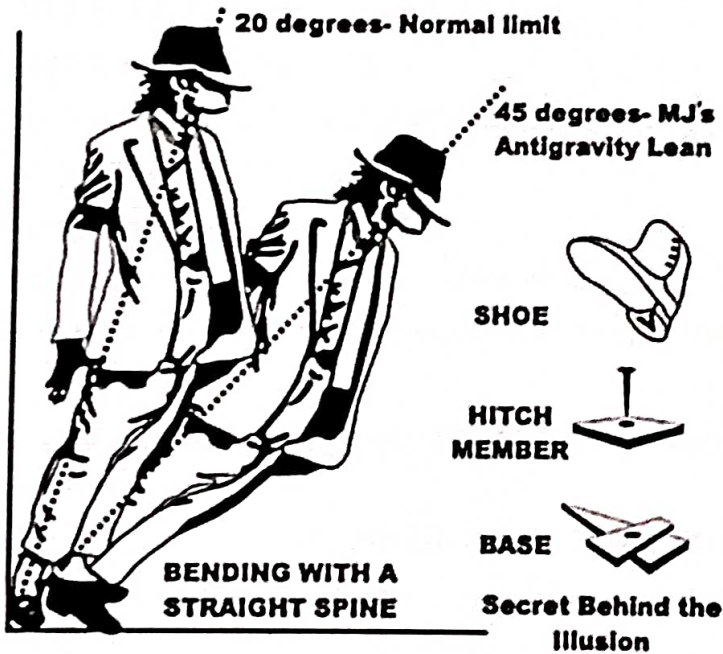
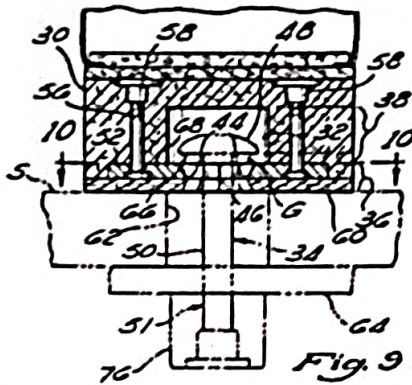
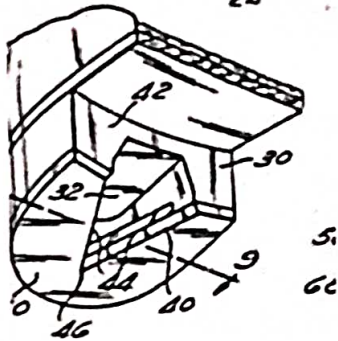
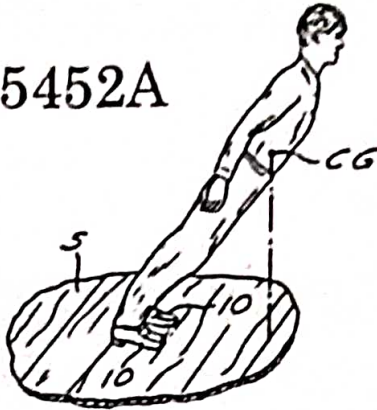
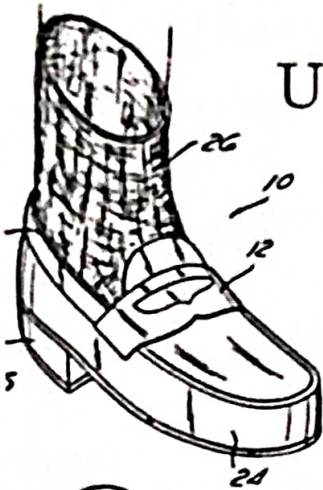

<https://www.npr.org/sections/therecord/2018/05/22/613306407/michael-jacksons-gravity-lean-continues-to-fascinate>

Asel
PRINCIPAL
 ANNAI VAILANKANNI COLLEGE OF ENGINEERS
 POTTALKULA
 AZHAGAPPAPURA
 SANKARAPURAM, DIST

Different IPs in a Single Product

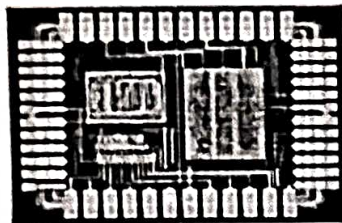
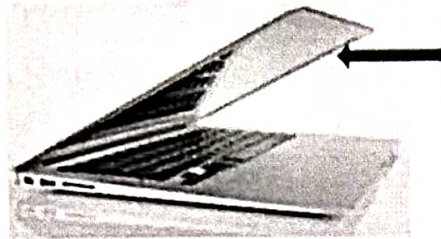
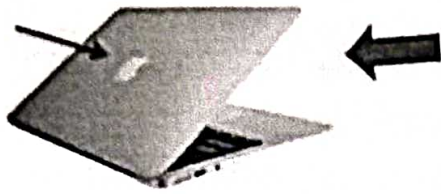

LED display- Patent
Body of laptop- Design
Apple sign- Trade Mark
User Manual- Copyright
layout of IC- SIDL Design

VALIDITY

- o Patents- 20 years term
There is nothing called global / international patent
- o Designs- 10 years + 5 years
- o Trade Marks- Indefinitely
- o GI-Indefinitely subject to renewal
- o Copyright- lifetime of the author + sixty years

Who can Apply:- Person (Individual not for GI) or legal representative

Person includes:- Firm, partnership, small entity and a body corporate

All IP rights are territorial in nature

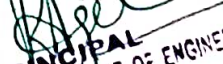

PRINCIPAL
ANNAL VAILANKANNI COLLEGE OF ENGINEERING
POTTALKULAM
AZHAGAPAPURAM - 629 401
NANTAKUMARI DIST.

POINTS TO REMEMBER

- First protect then Publish
- Rights are Territorial (Limited to boundary of Country/ sovereign authority), registration is required (in each country)*
- Registration is done by sovereign authority (i.e. Government of India)
- Rights for limited period of time
- No automatic relief. (Need to file infringement suit)
- Renewal fees to be paid for some IPRs*

* - Except Copyright and Trade secret

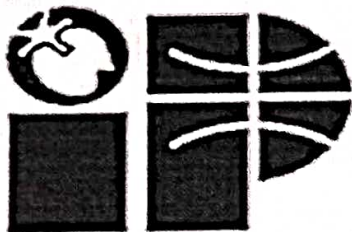
WEBSITE OF O/O CGPDTM



INTELLECTUAL
PROPERTY INDIA
PATENTS | DESIGNS | TRADE MARKS
GEOGRAPHICAL INDICATIONS

www.ipindia.gov.in

43

Asel
PRINCIPAL
ANNAI VAILANKANNI COLLEGE OF ENGINEERING
POTTALKULAM
AZHAGAPPAPURAM - 623 401
KANYAKUMARI DIST.

One who never asks either
knows everything or nothing
- Malcolm Forbes

Q & A

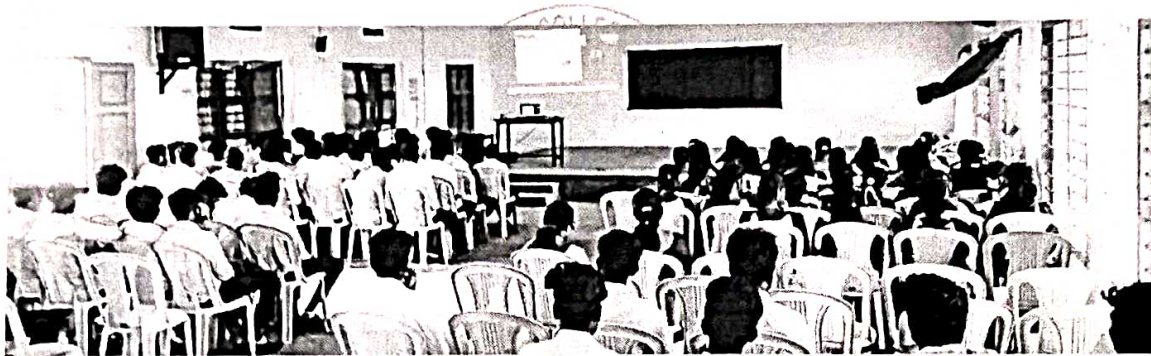

[Signature]
PRINCIPAL
ANNAI VAILANKANNI COLLEGE OF ENGINEERING
POTTALKULAM
AZHAGAPPAPURAM - 623 401
KANYAKUMARI DIST.

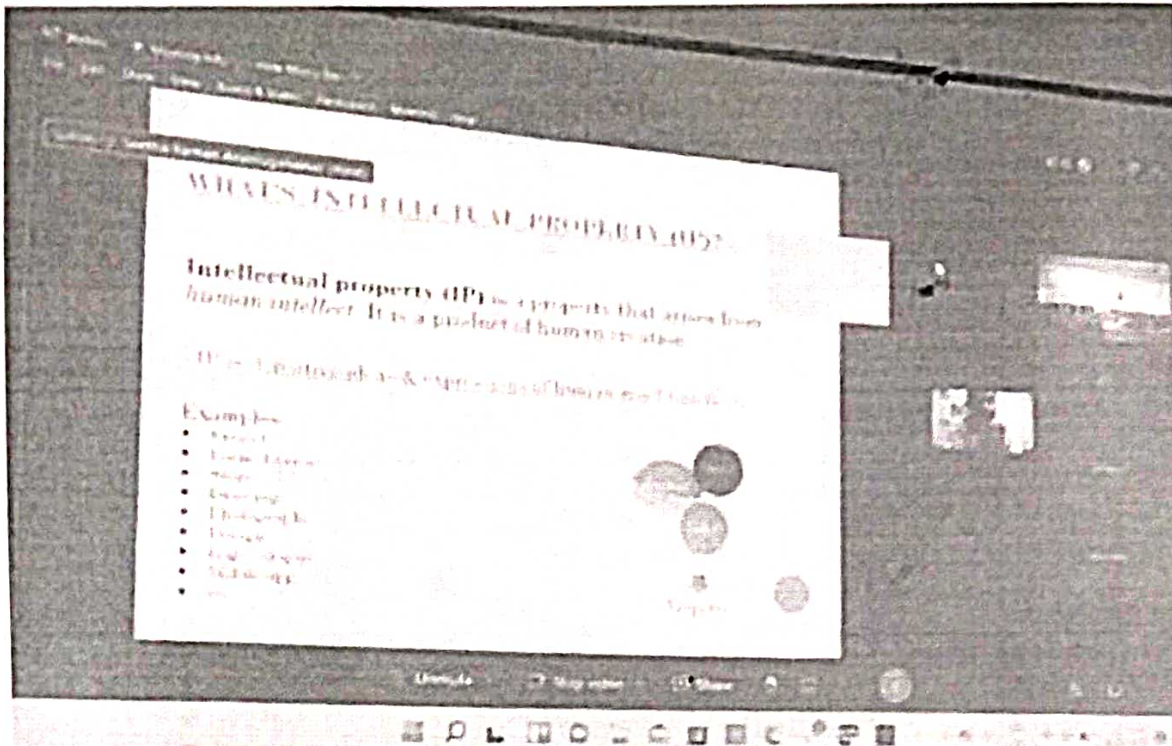

Following is the list of participants through Physical and Online mode:

Annai Vailankanni College Of Engineering			
Attendance Sheet			
Sl.No	Name	E-mail ID	Gender
1	PRIYANKA.J	p1622918@gmail.com	Female
2	JESHIKA.S	jeshikacedrica@gmail.com	Female
3	MONISHA .M	monimanohar2002@gmail.com	Female
4	RAGUL R	ragulraj3870@gmail.com	Male
5	ASHA	Ashaanu827@gmail.com	Female
6	KAVIYA	kkaviya56989@gmail.com	Female
7	ANTO SAHAYA JAIWIN.A	Antojaiwin143@gmail.com	Male
8	ANISH. M	anishmaniharan3@gmail.com	Male
9	R.T.MONIKA	rtmonika573@gmail.com	Female
10	ASHIKA M	ashika04m@gmail.com	Female
11	RACHEL.D	rachalsy4002@gmail.com	Female
12	A.PAVITHRA	Pavithra22553@gmail.com	Female
13	SELVA THARUN R R	selvatharunraiesh@gmail.com	Male
14	SRITHAR	srithardon1234@gmail.com	Male
15	A.MARIAMMAL	maheshmuthu2728@gmail.com	Female
16	SHEKA G	shekagnanasekar@gmail.com	Female
17	K. MUGUNTHAN MANO	muqunthanmano786@gmail.com	Male
18	A.VINOTH KUMAR	vinothkumaranthony@gmail.com	Male
19	N.MINI	minineelan1@gmail.com	Female
20	K.SHANTHINI	Santhinisanthini827@gmail.com	Female

Principal
 ANNAI VAILANKANNI COLLEGE OF ENGINEERING
 PO - TALKULAM
 AZHAGAPPURAM - 629 401
 KANYAKUMARI DIST.

21	ADITYAN V L	adityantvm2002@gmail.com	Male
22	R V DERVIN	dervindervin179@gmail.com	Male
23	S. PRIYANKA	Priyankastephan69@gmail.com	Female
24	A.S.PONSELVI	ponselvikannan2021@gmail.com	Female
25	SELVA PRIYA J	2selvapriya3@gmail.com	Female
26	SAM.J.DUFORT	josham2428@gmail.com	Male
27	JEROME S DOMINIC	jeromedominicv@gmail.com	Male
28	SWETHA	swethaleena83@gmail.com	Female
29	M.ANITHA	lvuani90044@gmail.com	Female
30	M. DHARSHINI	dharshiniabi576@gmail.com	Female
31	D.BHARADWAJ	waibharad1616@gmail.com	Male
32	SHARMI.J	sharmiie2003@gmail.com	Female
33	C. SAJITHA	assaji983@mail.com	Female
34	L.K.SHAMILI	shamilisham82@gmail.com	Female
35	PAVITHRA.K	Pavithraapp368@gmail.com	Female
36	KAVASKER	keinskavasker@gmail.com	Male
37	THAMEEMALHUSSAIN	thameemalhussain55@gmail.com	Male
38	N. LIBINESH	libinesh5555@gmail.com	Male
39	M.ASUWATHI	asuwathim@gmail.com	Female
40	A. MANIMURUGESWARAN	manimirugan007@gmail.com	Male
41	M.DEEPAK	deepakbalor2493@gmail.com	Male
42	R. DINESH	dinesh051176@gmail.com	Male
43	E BEBIN RAJ	ebebin2004@gamil.com	Male
44	A.ANISHA	aiithdon979@gmail.com	Female
45	JENIFER	jenifer26112003@gmail.com	Female
46	E BEBIN RAJ	ebebin2004@gamil.com	Male
47	S.S.ABIJITH	abiiithss2004@gmail.com	Male
48	ANISH.S	anishbeat7@gmail.com	Male
49	A.CATHERIN ROFICA	catherinrofica@gmail.com	Female
50	SNOJA	snojachittu@gmail.com	Male
51	KEEBO A.L	keeboreus@gmail.com	Male
52	D.RAVEEN	draveen945@gmail.com	Male
53	NISHA NANTHINI M.S.	nishananthinims@gmail.com	Female
54	A ABISHEK	aabishek.in26@gmail.com	Male
55	HARRIS.R	harrisharr47@gmail.com	Male
56	V.MARIAPPAN	mariappan9042753975@gmail.com	Male
57	M BRITTO SOLOMON	brittosolomon2@gmail.com	Male
58	DIVYA.M	mdivya819087@gmail.com	Female
59	PAVITHRA.P	pavi36029@gmail.com	Female
60	M. RAMAKRISHNAN	ramakrishnanmurugan04@gmail.com	Male
61	M.KANNIKA	mkannika607@gmail.com	Female
62	BAVI.K	bavibavi570@gmail.com	Female
63	JOTHI	Jothijothi77497@gmail.com	Female
64	N.SNEHA	sneha280220042004@gmail.com	Female
65	S.RAJA	josephraia512@gmail.com	Male
66	L.JINISHA	jinishal186@gmail.com	Female
67	JEGATHEESH	jegatheeshjegatheesh049@gmail.com	Male
68	PRAKASH S	prakash642004s@gmail.com	Male
69	HARISH MAN.S	harishking8190@gmail.com	Male
70	DEVI.S	sujiselvamani2002@gmail.com	Female
71	ANNIES RAVIN R	annieaa222@gmail.com	Male
72	S.SUBITHA	subikutty678@gmail.com	Female
73	I. JOHNSON JEBASEELAN	johnson.jieba603@gmail.com	Male
74	ABINESH.R	abineshabi27123@gmail.com	Male

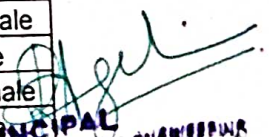
PRINCIPAL
ANNALYALAN COLLEGE OF ENGINEERING
POTTALKULAM
AZHAGAPURAM - 629 401
KANTANUR DIST.

75	KINGSHERIN	Kungsherin27@qamil.com	Male
76	SHIJO. D	Shijomass99@gmail.com	Male
77	S.ANUSHA	Sanushaanu472@gmail.com	Female
78	M.NOUFAL	noufalmaideen2801@gmail.com	Male
79	ANU DHARSHINI N	anunaqarajan03@gmail.com	Female
80	JOSELIN SHIJO	Joselinshijo9360@gmail.com	Male
81	K. BAVITHIRA	Pavithrak8098@gmail.com	Female
82	DINESHKUMAR. K	dineshk24270@gmail.com	Male
83	NISHA. M	nishamuruqesan999@gmail.com	Female
84	T. C. TINIS CHRISTAN JOE	Joemassjoedon@gmail.com	Male
85	S.ISHWARYA	ss.ishwarya2004@gmail.com	Female
86	BHARATH.S	vasanthaamma62@gmail.com	Male
87	ABINESH.R	abineshabi27123@gmail.com	Male
88	SALINI.I	lr9202051@gmail.com	Female
89	ANITHA M	ivuai90044@gmail.com	Female
90	NANTHINI S	nanthiniasm@gmail.com	Female
91	KRISHNAN	krishnankrishnan2003@gmail.com	Male
92	SUBIN	subinss390@gmail.com	Male
93	M.SIVA AKASH	sivadon685@gmail.com	Male
94	VISHWAHAR	diwavishwa08@gmail.com	Male
95	B JUDWIN DINO	binodino007@gmail.com	Male
96	ADWIN RAJ R	adwinking22@gmail.com	Male
97	HARISH KRISHNAN	directorc0012003@gmail.com	Male
98	JENITH J	jienith434@gmail.com	Male
99	JINO A	jinoai2004@gmail.com	Male
100	MICHAEL SUJIN X	mianclin82@gmail.com	Male
101	NITHIN REHOBOTH SALAL	salalnithi@gmail.com	Male
102	SUBITHA A	subitha645@gmail.com	Female
103	THANAMSEELAN C	sheelansheelan916@gmail.com	Male
104	VIJAY PRASAS VV	vijayprasad612004@gmail.com	Male
105	A ASHA	ashadhas304@gmail.com	Female
106	BELSI MARY S	blesimary992@gmail.com	Female
107	J JEBIN	mroggy102@gmail.com	Male
108	J SUBISHA	subishajayakumar99@gmail.com	Female
109	S MITHUNA	mithunamithuna512@gmail.com	Female
110	LIJU.L	liju.liju2002@gmail.com	Male
111	AKALYA. M	akalyaavce@gmail.com	Female
112	DHANESH	dhaneshece2018@gmail.com	Male
113	MABLE VIMALA S	mable.s140302@gmail.com	Female
114	N.AKILAN	akilanece2019@gmail.com	Male
115	JERISHA C	jerishac2001@gmail.com	Female
116	SARANYA.T	saranyathanqaraiendran@gmail.com	Female
117	NANTHINI.NS	nanthini2001ns@gmail.com	Female
118	NAVEEN KUMAR S	naveen20062002@gmail.com	Male
119	BABISHA M	babishamuruqan@gmail.com	Female
120	R.THANA REKA	thanareka18@gmail.com	Female

121	V. KAVITHA	VSkavitha811@gmail.com	Female
122	A.NANTHINI	ananthini143@gmail.com	Female
123	PONSEKAR. C	ponsekar003@gmail.com	Male
124	SANTHOSH.G	santhoshiyappan456@gmail.com	Male

I hereby submit the report for your kind perusal.

Thank you,



Prof. Lalu Gladson Robin,

Coordinator,

Entrepreneurship Development Cell,

Annai Vailankanni College of Engineering.

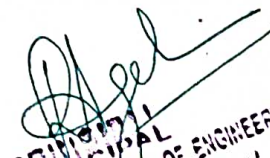

PRINCIPAL
ANNAI VAILANKANNI COLLEGE OF ENGINEERING
POTTALKULAM
AZHAGAPPAPURAM-629 401
KANNIYAKUMARI DIST.



ANNAI VAILANKANNI

College of Engineering

REPORT

On



On

Topic

“Placement and Entrepreneurship Opportunities”

conducted on

5/02/2022

Entrepreneurship Development Cell

Report on Webinar in the topic “Placement and Entrepreneurship Opportunities” on 5th February 2022

On 29th January 2022, webinar was conducted in the topic, “Role of an Entrepreneur in Today’s Generation” through Unacademy App Live telecast. The event was sponsored by Tamil Nadu government Entrepreneurship Development & Innovation Institute (EDII-TN) through Academic Innovation and Entrepreneurship Development Programme.

Date: 05-02-2022

Time: 10.a.m to 11.a.m

Meeting link: <https://unacademy.com/course/placement-and-entrepreneurship-opportunities/9G94YJ5J>

Access code: VIVEKGATE20

Participants: All AVCE students



Mr. Vivekanandan discussed the ideas and prospects available to an entrepreneur in this webinar. He also discussed how to turn ideas into businesses and how to fund them through government and private programmes. The presentation concludes with an overview of the topic and its future applications. A total of 100 students took part in the webinar. Mrs. V.S. Jiji, Assistant Professor and Co-Coordinator of the Entrepreneurship Development Cell, coordinated the event.

PRINCIPAL
ANNAI VAILANKANNI COLLEGE OF ENGINEERING
POTTALKULAM
AZHAGAPPAPURAM - 629 401
KANTAKUMARI DIST.



ANNAI VAILANKANNI COLLEGE OF ENGINEERING

Recognized under section 2(f) of UGC Act, 1956
Permanent Affiliation for B.E.- Computer Science And
Engineering

JOIN OUR WEBINAR ON

Placement & Entrepreneurship Opportunities

In association with



DATE 05-02-2022

TIME 10.00 am

PLATFORM

Google meet

RESOURCE PERSON



Mr. VIVEKANANDAN.R

GATE EDUCATOR
UNACADEMY

Mobile: 9629285139

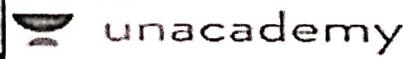

Organized by
Entrepreneurship
Development
Cell

Coordinator:

Mrs. JIJU V.S,
AP, Civil, AVCE
9442028815

You are cordially Invited to be a part of the Webinar
www.avce.edu.in

PRINCIPAL
ANNAI VAILANKANNI COLLEGE OF ENGINEERING
POTTALKULAM
AZHAGAPPAPURAM - 629 401
KANYAKUMARI DIST.

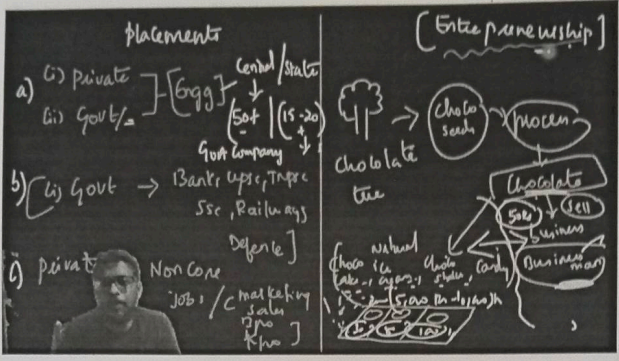

- Adityan v... joined
- D Jeevitha joined
- Karthika joined
- Maria joined
- Blessingta... joined

You can now talk to the educator by raising your hand in the class

- Jiji joined
- Nithya joined
- Jensi joined
- Supriya joined
- Mut... joined

Comment ? 🗨️ 😊

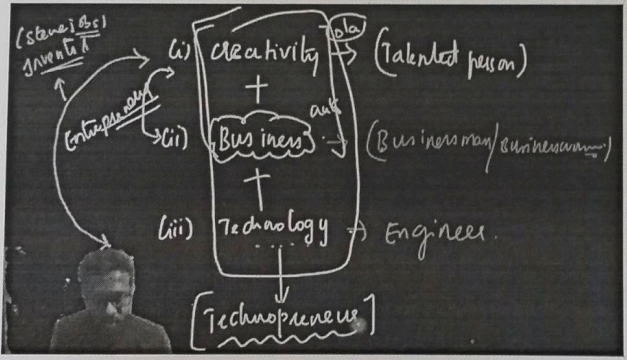

- Kavitha joined
- Jiji joined
- Nithya joined
- Jensi joined
- Supriya joined

You can now talk to the educator by raising your hand in the class

- Sp joined
- Antony joined
- Sureshraj joined
- Subathra joined
- Pri... joined

Comment ? 🗨️ 😊

Agel
PRINCIPAL
 ANNAI VAILANKANNI COLLEGE OF ENGINEERING
 POTTALKULAM
 AZHAGAPPURAM - 629 401
 KANYAKUMARI DIST.

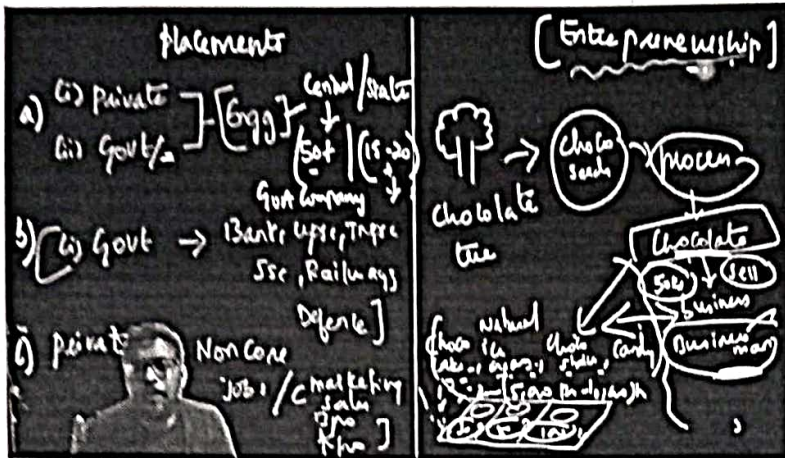

Adityan v... joined

D Jeevitha joined

Karthika joined

Marla joined

Blessingta... joined

You can now talk to the educator by raising your hand in the class

Jiji joined

Nithya joined

Jensl joined

Supriya joined

Mul... joined

Comment

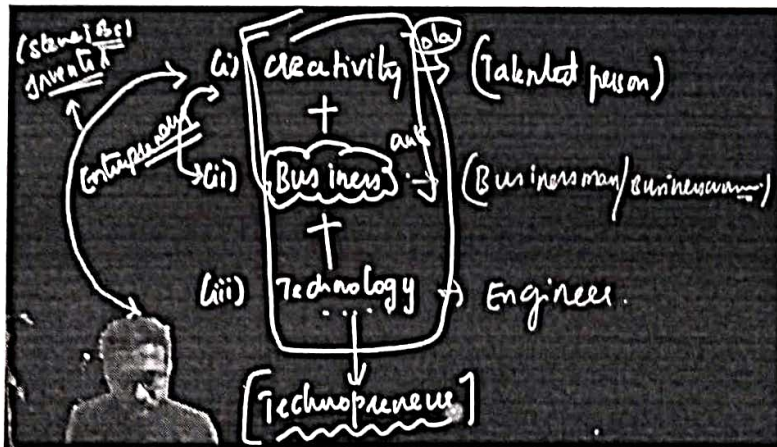

Kavitha joined

Jiji joined

Nithya joined

Jensl joined

Supriya joined

You can now talk to the educator by raising your hand in the class

Sp joined

Antony joined

Sureshraj joined

Subathra joined

Pri... joined

Comment

Asel

PRINCIPAL
ANNAI VAILANKANNI COLLEGE OF ENGINEERING
POTTALKULAM
AZHAGAPPAPURAM - 623 401
KANYAKUMARI DIST.

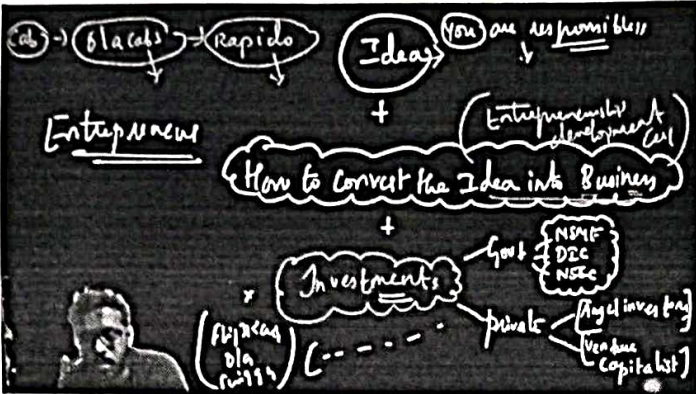

Jerisha joined

Kavitha joined

Jiji joined

Nithya joined

Jensi joined

You can now talk to the educator by raising your hand in the class

Vivekanand... joined

Sp joined

Antony joined

Sureshroja joined

Suba... joined

Comment

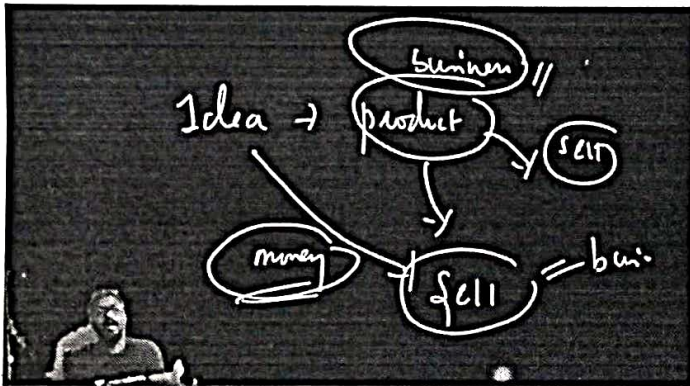

Adityan.v... joined

D Jeevitha joined

Karthika joined

Maria joined

Blessingta... joined

You can now talk to the educator by raising your hand in the class

Jiji joined

Nithya joined

Jensi joined

Supriya joined

Mut... joined

Comment

I hereby submit the report for your kind perusal.

Thank you,

Prof. Lalu Gladson Robin,

Coordinator,

Entrepreneurship Development Cell,

Annai Vailankanni College of Engineering.

PRINCIPAL
ANNAI VAILANKANNI COLLEGE OF ENGINEERING
POTTALKULAM
AZHAGAPPAPURAM - 629 401
KANTHAKUMARI DIST.



ANNAI VAILANKANNI

College of Engineering

REPORT

On



On

Topic

“Empowering Women through Skill development”

conducted on

8/03/2022

Entrepreneurship Development Cell

Report on Webinar in the topic "Empowering women through skill development" on 8th March 2022

On 8th March 2022, webinar was conducted in the topic, "Empowering women through skill development" through Google Meet and YouTube Live telecast.

Date : Tuesday, March 8, 2022.

Time : 11:00 AM – 12:30 PM

Google meet link : <https://meet.google.com/qid-azgu-sxc>

Participants : All AVCE Students

The webinar was conducted in association with the Rotary Club of Nagercoil South. Rtn. Ashwin, President of Rotary Club of Nagercoil South inaugurated the webinar. Rtn. Muthiah Pillai, District Governor Nominee, graced the meeting with his chief guest address. The session was handled by the resource person Ms. Swathi Krishnan (mobile: 8076074265), an accountability coach & an International Karalakattai Coach, Founder of YesPeopletainment, Delhi. About 95 students participated through google meet. Er. Philip Dani, Director, Annai Vailankanni delivered the felicitation and concluded the session.

PRINCIPAL
ANNAI VAILANKANNI COLLEGE OF ENGINEERING
POTTALKULAM
AZHAGAPPAPURAM - 629 401
KANYAKUMARI DIST.



ANNAI VAILANKANNI COLLEGE OF ENGINEERING

Recognized under section 2(f) of UGC Act, 1956
Permanent Affiliation for B.E – Computer Science and Engineering

In association with

Rotary



SERVE TO
CHANGE LIVES

WEBINAR ON

Empowering women
through skill
development

Organized by

Entrepreneurship Development Cell



Swathi Krishnan

An Accountability Coach & an International Karalakattai Coach
Founder of YesPeopletainment, Delhi

Convener : Mr. Lalu Gladson Robin, Asso. Prof., Mech
You are cordially Invited to be a part of the webinar

Date : 8th March 2022

Time : 11.00 am



Google meet

<https://meet.google.com/qid-azgu-sxc>



www.avce.edu.in

PRINCIPAL
ANNAI VAILANKANNI COLLEGE OF ENGINEERING
POTTALKULAM
AZHAGAPPAPURAM - 623 401
KANNIYAKUMARI DIST.

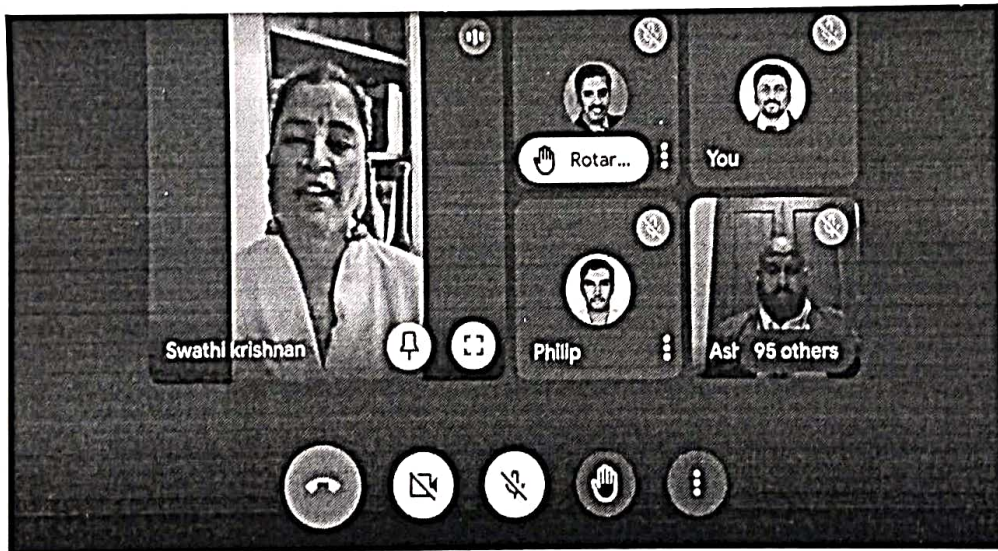
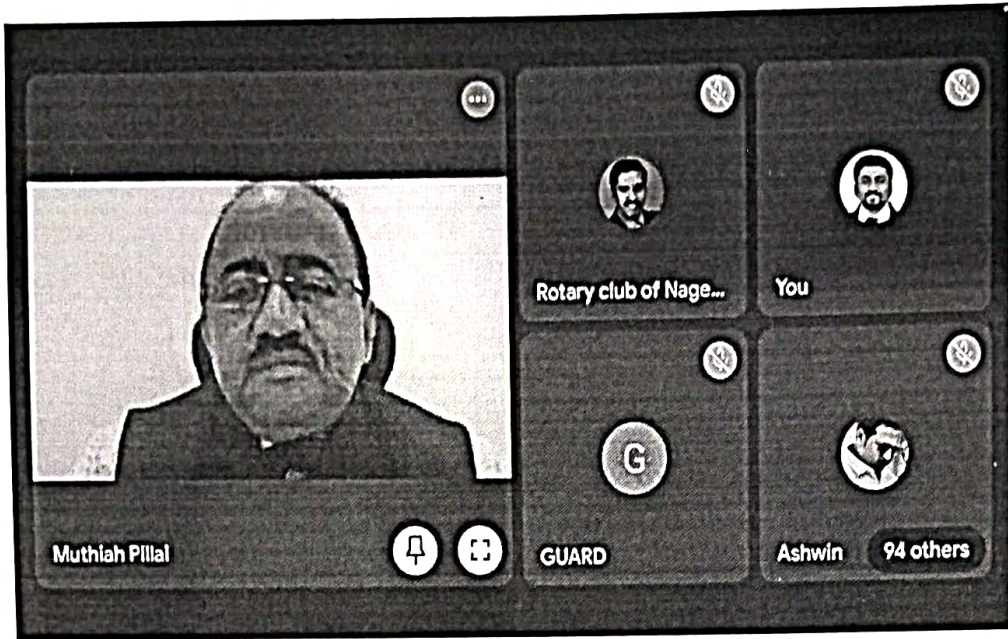

List of Participants:

Sl.No.	Name	E-mail ID
1	Priyanka.J	p1622918@gmail.com
2	JESHIKA.S	jeshikacedrica@gmail.com
3	Monisha .M	monimanohar2002@gmail.com
4	Ragul R	ragulraj3870@gmail.com
5	Asha	Ashaanu827@gmail.com
6	KAVIYa	kkaviya56989@gmail.com
7	Anto sahaya jaiwin.A	Antojaiwin143@gmail.com

PRINCIPAL
 ANNAI VAILANKANNI COLLEGE OF ENGINEERING
 POTTALKULAM
 AZHAGAPPAPURAM - 629 401
 KANTAKUMARI DIST.

8	Anish. M	anishmaniharan3@gmail.com
9	R.T.Monika	rtmonika573@gmail.com
10	Ashika M	ashika04m@gmail.com
11	RACHEL.D	rachalsy4002@gmail.com
12	A.pavithra	Pavithra22553@gmail.com
13	Selva Tharun R R	selvatharunrajesh@gmail.com
14	Srithar	srithardon1234@gmail.com
15	A.Mariammal	maheshmuthu2728@gmail.com
16	Sheka G	shekagnanasekar@gmail.com
17	K. Mugunthan Mano	mugunthanmano786@gmail.com
18	A.vinoth kumar	vinothkumaranthony@gmail.com
19	N.Mini	minineelan1@gmail.com
20	K.Shanthini	Santhinisanthini827@gmail.com
21	Adityan V L	adityantvm2002@gmail.com
22	R V Dervin	dervindervin179@gmail.com
23	S.Priyanka	Priyankastephan69@gmail.com
24	A.S.Ponselvi	ponselvikannan2021@gmail.com
25	Selva Priya J	2selvapriya3@gmail.com
26	Sam.j.dufort	josham2428@gmail.com
27	Jerome S Dominic	jeromedominicv@gmail.com
28	Swetha	swethaleena83@gmail.com
29	M.Anitha	lvuani90044@gmail.com
30	M. Dharshini	dharshiniabi576@gmail.com
31	D.Bharadwaj	wajbharad1616@gmail.com
32	Sharmi.J	sharmiie2003@gmail.com
33	C. Sajitha	assaji983@mail.com
34	L.K.Shamili	shamilisham82@gmail.com
35	Pavithra.k	Pavithraapp368@gmail.com
36	Kavasker	keinskavasker@gmail.com
37	Thameemalhussain	thameemalhussain55@gmail.com
38	N. Libinesh	libinesh5555@gmail.com
39	M.Asuwathi	asuwathim@gmail.com
40	A. Manimurugeswaran	manimirugan007@gmail.com
41	M.Deepak	deepakbalor2493@gmail.com

PRINCIPAL
 ANNAL VAILANKANNI COLLEGE OF ENGINEERING
 POTTALKULAM
 AZHAGAPPAPURAM - 629 401
 KANYAKUMARI DIST.

42	R. Dinesh	dinesh061176@gmail.com
43	E BEBIN RAJ	ebebin2004@gamil.com
44	A Anisha	ajithdon979@gmail.com
45	Jenifer	jenifer26112003@gmail.com
46	E Bebin Raj	ebebin2004@gamil.com
47	S.S. Abijith	abijiths2004@gmail.com
48	Anish.S	anishbeatz7@gmail.com
49	A.Catherin Rofica	catherinrofica@gmail.com
50	Snoja	snojachittu@gmail.com
51	Keebo A.L	keeboreus@gmail.com
52	D.Raveen	draveen945@gmail.com
53	Nisha Nanthini M.S.	nishananthinims@gmail.com
54	A Abishek	aabishek.in26@gmail.com
55	Harris.R	harrisharr47@gmail.com
56	V.Mariappan	mariappan9042763976@gmail.com
57	M Britto Solomon	brittosolomon2@gmail.com
58	Divya.m	mdivya019007@gmail.com
59	pavithra.p	pavi36020@gmail.com
60	M. Ramakrishnan	ramakrishnanmurugan04@gmail.com
61	M.kannika	mkannika607@gmail.com
62	Bavi.k	bavibavi570@gmail.com
63	Jothi	JothiJothi77407@gmail.com
64	N.sneha	sneha280220042004@gmail.com
65	S.Raja	Josephraja512@com
66	L.JINISHA	jinishal186@gmail.com
67	Jegatheesh	JegatheeshJegatheesh049
68	Prakash s	prakash642004s@gmail.com
69	HARISH MAN.S	harishking8190@gmail.com
70	Devi.S	sujselvamani2002@gmail.com
71	Annles Ravin R	annleaa222@gmail.com
72	S.subltha	subikutty678@gmail.com
73	I. Johnson Jebaseelan	Johnson.jeba603@gmail.com
74	Abinesh.R	abineshabi27123@gmail.com
75	Kingsherin	Kungsherin27gamil.Com

PRINCIPAL
 ANNAL VAILANKANNI COLLEGE OF ENGINEERING
 POTTAL KULAM
 AZHAGAPPAPURAM - 629 401
 KANYAKUMARI DIST.

76	Shijo. D	Shijomass99
77	S.Anusha	Sanushaanu472@gmail.com
78	M.Noufal	noufalmaideen2801@gmail.com
79	Anu Dharshini N	anunagarajan03@gmail.com
80	Joselin shijo	Joselinshijo9360@gmail.com
81	K. Bavithira	Pavithrak8098@gmail.com
82	Dineshkumar. K	dineshk24270@gmail.com
83	Nisha. M	nishamurugesan999@gmail.com
84	T. C. Tinis christan joe	Joemassjoedon
85	S.Ishwarya	ss.ishwarya2004@gmail.com
86	Bharath.S	vasanthaamma62@gmail.com
87	Abinesh.R	abineshabi27123@gmail.com
88	Salini.I	lr9202051@gmail.com
89	S.subin	subinss390@gmail.com
90	Abish.R	abish0321@gmail.com
91	Subisha.J	subishajayakumar99@gmail.com
92	Krishnan.G	krishnankrishnan2003g@gmail.com
93	Karthigai selvan	karthimail60@gmail.com
94	A. Thanush	athanush77@gmail.com
95	S.Ram Prasad	ramprasadshanmugam6@gmail.com

I hereby submit the report for your kind perusal.

Thank you,



Prof. Lalu Gladson Robin,

Head,

Entrepreneurship Development Cell,

Annai Vailankanni College of Engineering.

PRINCIPAL

ANNAI VAILANKANNI COLLEGE OF ENGINEERING

POTTALKULAM

AZHAGAPPAPURAM - 629 401

KANYAKUMARI DIST.

5.1.3 Percentage of students benefitted by guidance for competitive examinations and career counselling offered by the Institution

Year	Guidance for competitive examinations			Details of career counselling		
	Name of the Activity	Number of students participated	Number of students qualified in the competitive examinations	Name of the Activity	Number of students participated	Number of students place
2022-2023	ECC Academy-Civil service	67		Career guidance program-Varenda	67	62
				Career guidance program-Knowit	67	
			Nil	TNSI awareness camp	67	
				Awareness Program on "Becoming an Entrepreneur"	124	
2021-2022	Awareness & Quiz on Gate -UN academy	100		Awareness Program on "One Million Ideas"	60	78
				Awareness Program on "Intellectual Property Rights"	124	
			Nil	Placement & Entrepreneurship Opportunities	100	
				Empowering Women through skill development	95	
2020-2021	Aptitude Training by FACE	65		Aptitude and Soft skill training by Naandhi	96	63
			Nil			
2019-2020	Time Management in Examination -ECC Academy	235	Nil	Awareness program on "Becoming an Entrepreneur"	124	61

2018-2019	Awareness Session on UPSC/TNPSC	250		Personality Development Program	76	40
			1			

COMPETITIVE EXAMINATIONS



ANNAI VAILANKANNI
College of Engineering

REPORT
on
Career Guidance Program

On

28/02/2023

Training and Placement Cell

Report on Career Guidance Program On 13/02/2023

Training and Placement Cell organized a Career Guidance Program on 28th February 2023 at Annai Vailankanni College of Engineering in association with ECC Academy Nagercoil. Training and Placement Cell is always motivating the students to upskill their careers.

The main purpose of the program is to create awareness about the Civil Service Examination in young minds. Mr. Ananda Boopathi MD, ECC Academy is the resource person of this program. He elaborated on the opportunities and details of the Civil Service Examinations. Totally 67 final-year students participated from various departments.



ANNAI VAILANKANNI COLLEGE OF ENGINEERING
Azhagappapuram Post – 629 401, K.K. Dist, Tamil Nadu

CAREER GUIDANCE PROGRAM

PROGRAM SCHEDULE

February 28, 2023

10.00 am	Prayer Song	:	College Choir
10.10 am	Welcome Address	:	Mr. B. Roberts TPO, AVCE
10.15 am	Presidential Address	:	Dr. N. Abilash Principal I/C, AVCE.
10.30 am	Chief Guest Address	:	Mr. Ananda Boopathi. MD, ECC Academy.
10.55 am	Vote of thanks	:	Ms. A. Nanthini IV ECE.
11.00 am	National Anthem	:	College choir

PRINCIPAL
ANNAI VAILANKANNI COLLEGE OF ENGINEERING
POTTALKULAM
AZHAGAPPAPURAM - 629 401
KANTAKUMARI DIST.



ANNAI VAILANKANNI COLLEGE OF ENGINEERING

A.V.K. NAGAR, AZHAGAPPAPURAM POST, KANYAKUMARI DISTRICT, TAMILNADU-629 601.

CAREER GUIDANCE PROGRAM

RESOURCE PERSON

Mr. T ANANDA BOOPATHY (MD)



ECC ACADEMY

DATE : 28-02-2023

TIME : 10:00 am

VENUE : BOSCH TRAINING ROOM

CO-ORDINATOR

Mrs. S HEPHZIBHA GOLDIN GEORGINI
AP / CIVIL

CONVENER

Mr. R ROBERT
TPD

PRINCIPAL

Dr. N ABILASH
AVCE

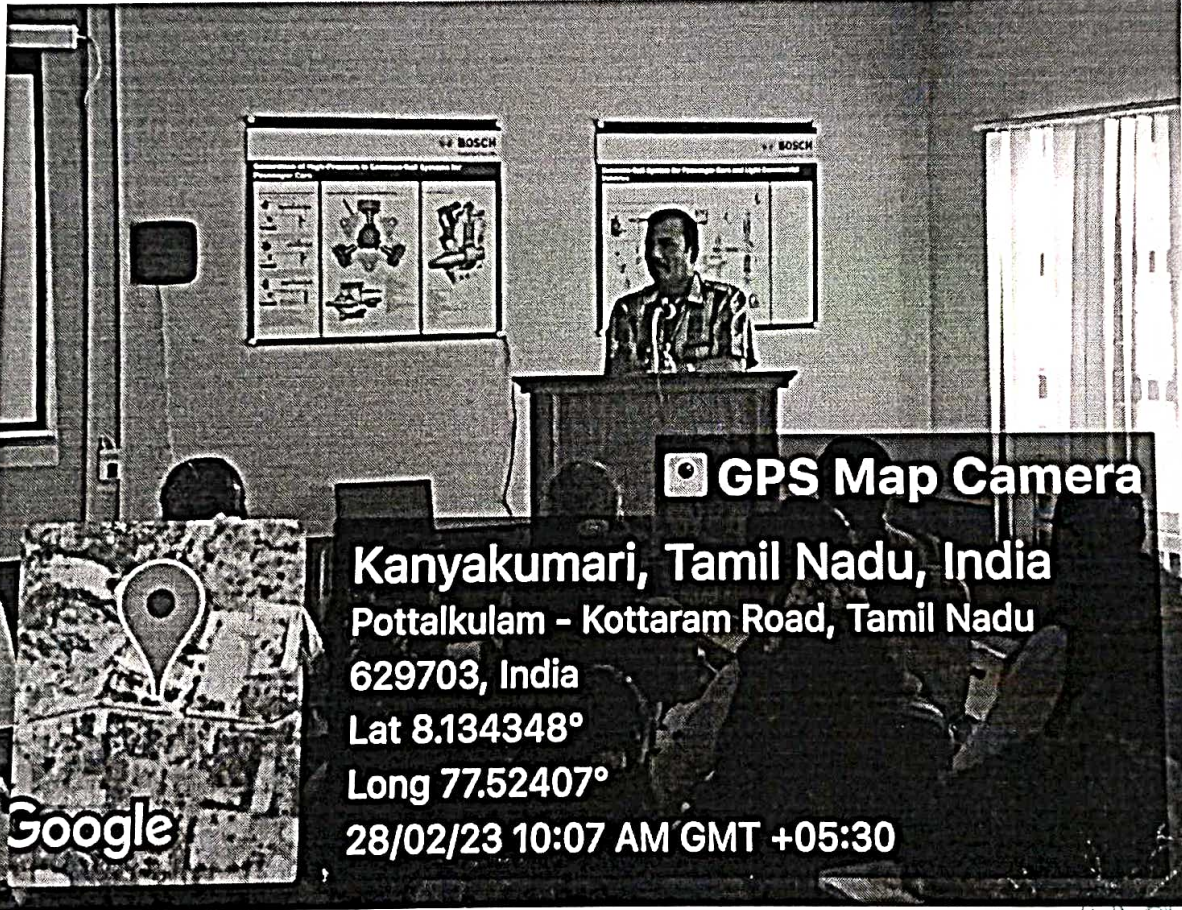
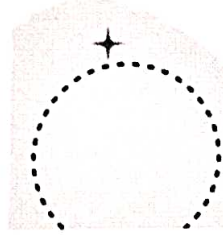

GPS Map Camera

Kanyakumari, Tamil Nadu, India

Pottalkulam - Kottaram Road, Tamil Nadu

629703, India

Lat 8.134348°

Long 77.52407°

28/02/23 10:07 AM GMT +05:30

Google

PRINCIPAL
ANNAI VAILANKANNI COLLEGE OF ENGINEERING
POTTALKULAM
AZHAGAPPAPURAM
KANYAKUMARI DIST.

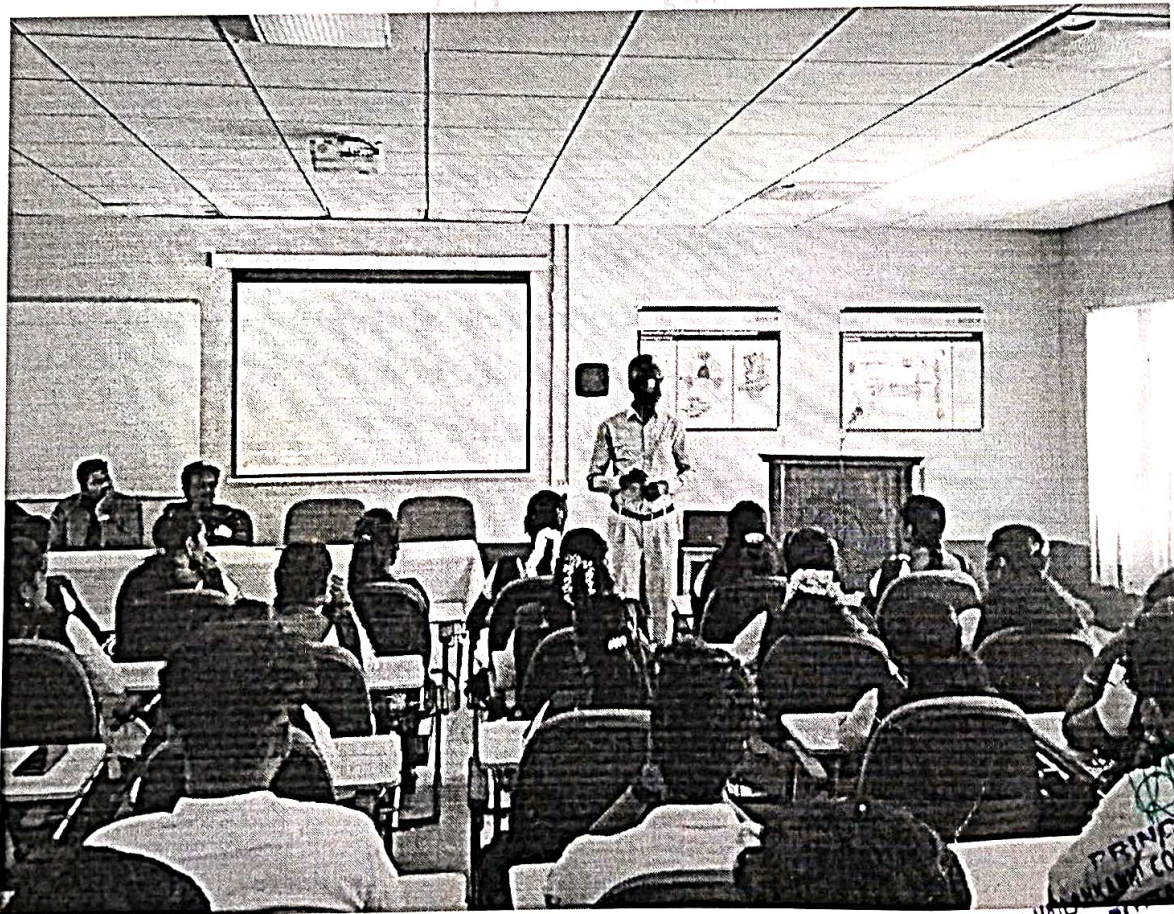

Handwritten signature
PRINCIPAL
ANNA UNIVERSITY
AZHAGADAMPALAM
KANNIYAKUMARI DIST. 101

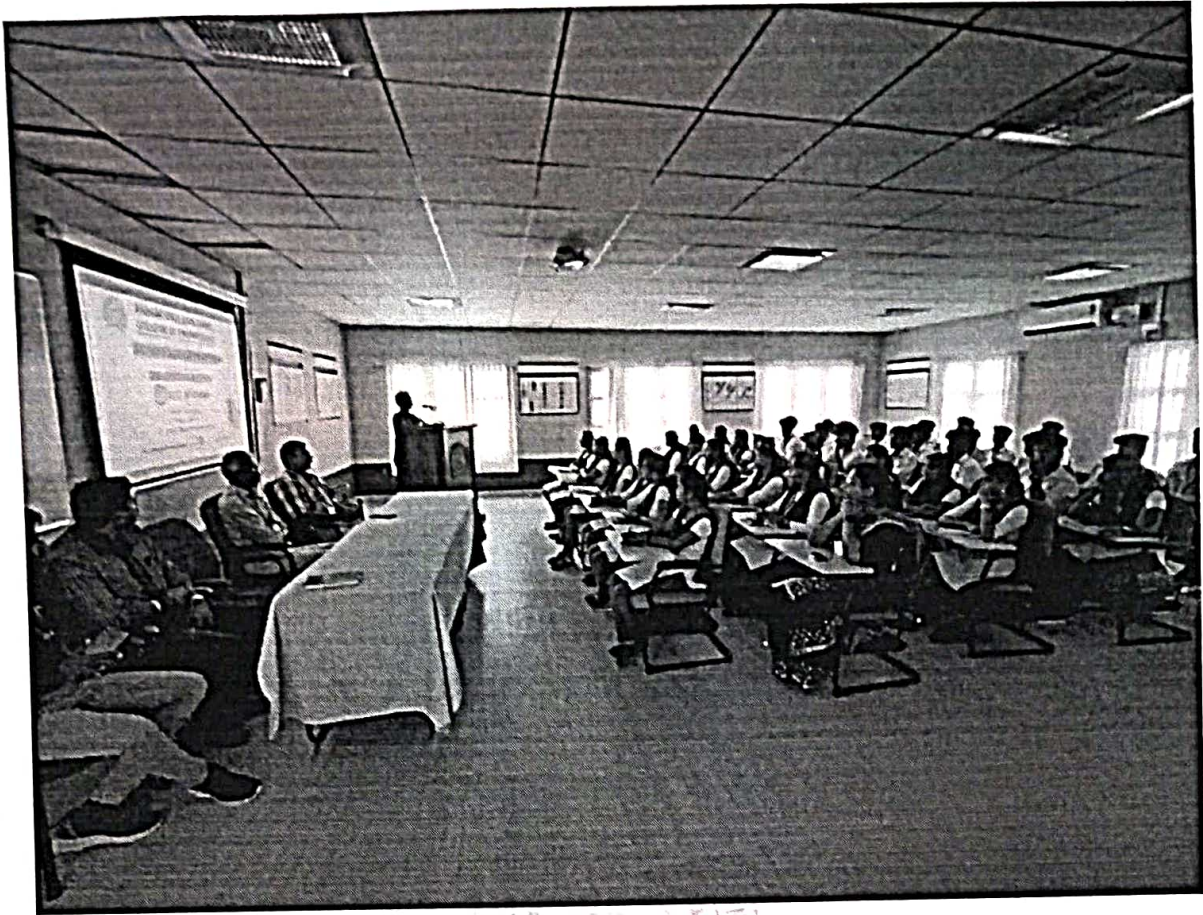

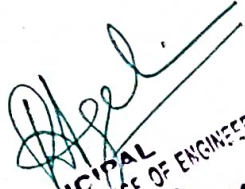

PRINCIPAL
ANNAI VAILANKANNI COLLEGE OF ENGINEERING
POTTALKULAM
AZHAGAPPAPURAM - 629 401
KANYAKUMARI DIST.

S.No	Register Number	Name
1	96011910600	S Aarth
2	96011910600	M Akal
3	96011910600	N akila
4	96011910600	M Babl
5	96011910600	R Dhar
6	96011910600	C Jeris
7	96011910600	V Kavil
8	96011910600	L Liju
9	96011910601	S Mabi
10	96011910601	A Nanc
11	96011910601	N S Na
12	96011910601	S Nave
13	96011910601	Pon sh
14	96011910601	R V Ra
15	96011910601	G Sant
16	96011910601	T sarar
17	96011910601	Thana
18	960119114002	ASHISI
19	960119114003	BINOL
20	960119114004	DINESI
21	960119114005	JENISE
22	960119114006	KARTH
23	960119114007	KAVIY.
24	960119114009	MIRLI
25	960119114010	MUJISI
26	960119114011	MUTHI
27	960119114012	NAGA

28	960119114013	NAVEE
29	960119114014	NITHEI
30	960119114015	PALAN
31	960119114016	SANGE
32	960119114017	SATHIS
33	960119114019	SIVA AI
34	960119114020	SIVA S/
35	960119114022	SUMITI
36	960119114023	THIANL
37	960119114024	THIARN
38	960119114025	UDAYA
39	960119114026	VASAN
40	960119114027	VINOTI
41	960119114028	YUVAR
42	960119114301	ABINEE
43	960119114302	ASHIOK
44	960119114304	GEORG
45	960119114305	MUTHI
46	960119103001	CHITRA
47	960119103002	KARTHI
48	960119103003	LAKSHM
49	960119103004	SUBINR
50	960119103005	UMA R
51	960119104001	ABIRAI
52	960119104002	AJAY .A
53	960119104003	ANTON
54	960119104004	ASIA JL
55	960119104005	AVINEE
56	960119104006	BALA SI
57	960119104008	ISHWAR
58	960119104009	KANAK
59	960119104010	KAVIN .
60	960119104011	LIPTO S
61	960119104012	MARIAI
62	960119104013	PRATHE
63	960119104014	RANISII
64	960119104015	RONALI
65	960119104016	SELVA P
66	960119104017	SIVA RA
67	960119104018	SOWMI

This report includes images and a copy of the attendance sheet for your convenience.

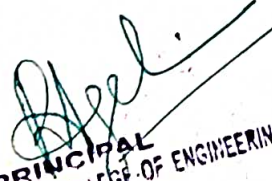
Thank you,

PRINCIPAL
ANNAI VAILANKANNI COLLEGE OF ENGINEERING
POTTALKULAM
AZHAGAPPANURAM - 629 401
KANTAKUMARI DIST

Mr. R. Robert, M.E.(Ph.D),
Head,
Training and Placement Cell,
Annai Vailankanni College of Engineering.

CAREER COUNSELLING



ANNAI VAILANKANNI
College of Engineering

REPORT
on
Career Guidance Program

On

09/02/2023

Training and Placement Cell

Report on Career Guidance Program On 09/02/2023

Training and Placement Cell organized a Career Guidance Program on 9th February 2023 at Annai Vailankanni College of Engineering in association with Veranda Race Nagercoil. Training and Placement Cell is always motivating the students to upskill their careers.

The main purpose of the program is to create awareness about the Vacancies in State and Government sectors to the young minds. Mrs. P.Delphine Rani Senior team leader, Veranda Race Nagercoil is the resource person for this program. She elaborated on the opportunities and details of the Job openings in the State and Government sectors. Totally 67 final-year students participated from various departments.



ANNAI VAILANKANNI COLLEGE OF ENGINEERING
AZHAGAPPAPURAM Post – 629 401, K.K. Dist, Tamil Nadu

CAREER GUIDANCE PROGRAM

PROGRAM SCHEDULE

February 09, 2023

10.00 am	Prayer Song	:	College Choir
10.10 am	Welcome Address	:	Mr.R.Robert TPO, AVCE
10.15 am	Presidential Address	:	Dr. N.Ablash Principal I/C, AVCE.
10.30 am	Chief Guest Address	:	Mrs.Delphine Rani. Sr. Team Leader.
10.55 am	Vote of thanks	:	Mr.Amal IV AD.
11.00 am	National Anthem	:	College choir

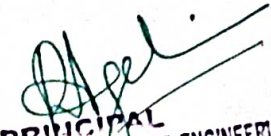
PRINCIPAL
ANNAI VAILANKANNI COLLEGE OF ENGINEERING
POTTALKULAM
AZHAGAPPAPURAM 629 401
KANNIYAKUMARI DIST.



ANNAI VAILANKANNI COLLEGE OF ENGINEERING

AVK Nagar, Pottalkulam, Kanyakumari District.

Recognized under section 2(f) of UGC act, 1956

Approved by AICTE, New Delhi & Affiliated to Anna University, Chennai.

CAREER GUIDANCE PROGRAM



Trainer:

**Mrs. P. DELPHINE RANI, M.Sc.,
Senior Team Leader,
Veranda RACE, Nagercoil.**

TRAINING AND PLACEMENT CELL

Date: 9th Feb 2023

Venue: BOSCH TRAINING ROOM,
ADMINISTRATIVE BLOCK

www.avce.edu.in



[Signature]
**PRINCIPAL
ANNAI VAILANKANNI COLLEGE OF ENGINEERING
POTTALKULAM
AZHAGAPPURAM - 629 401
KANTAKUMARI DIST.**

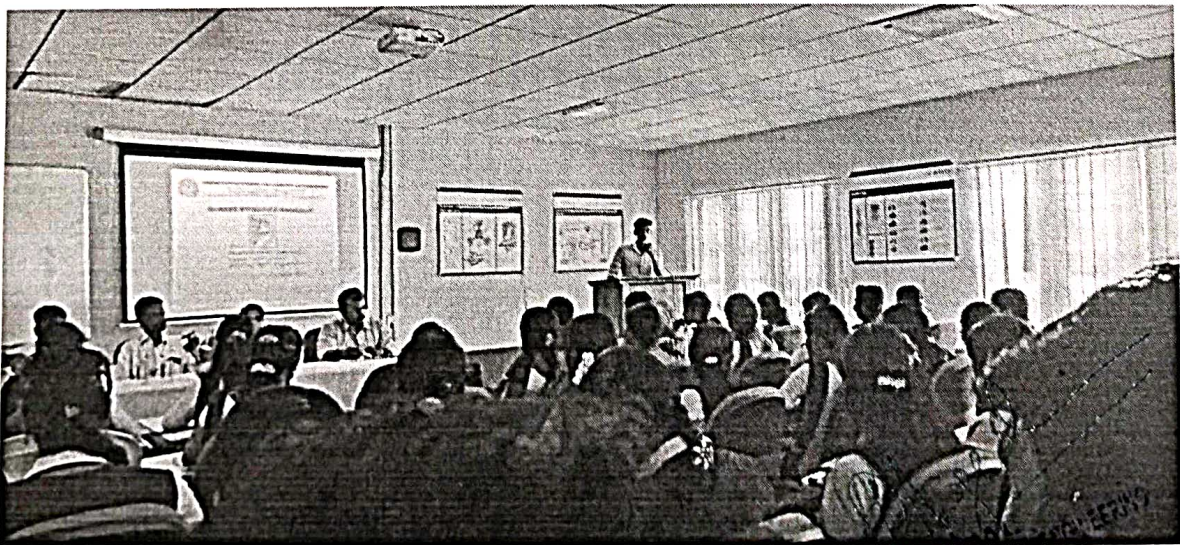
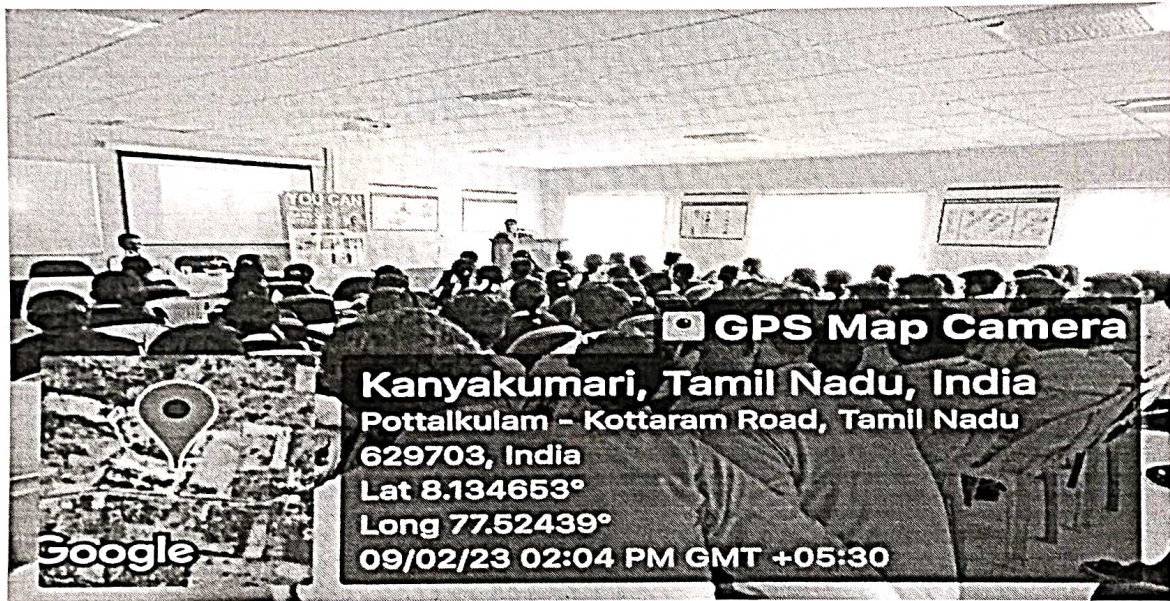
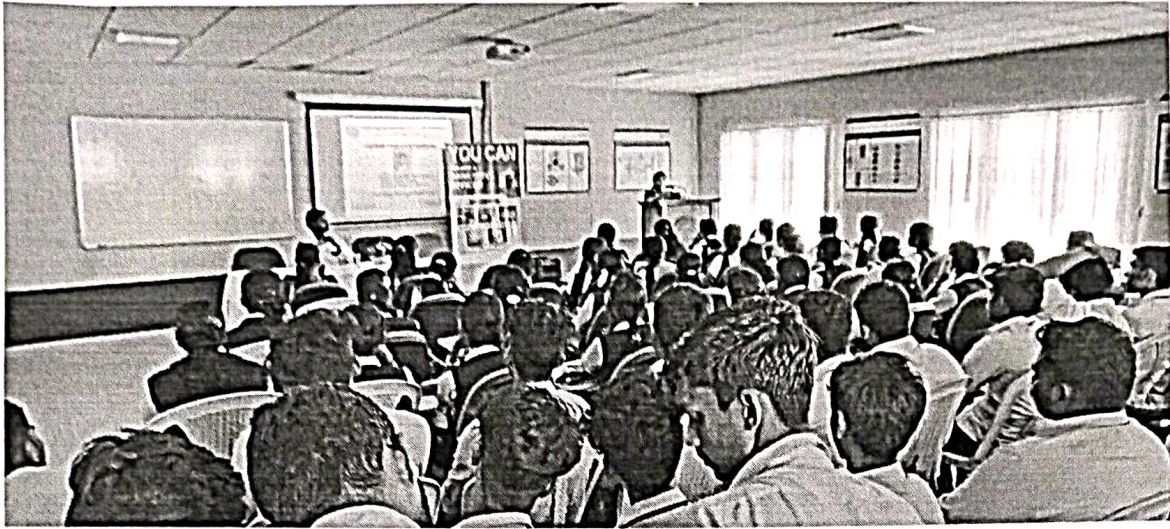

PRINCIPAL
ANNAI VAILANKANNI COLLEGE OF
POTTALKULAM
AZHAGAPPURAM - 629 401
KANYAKUMARI DIST.

S.No	Register Number	Name
1	00011010000	S Arath
2	00011010000	M Akal
3	00011010000	N Akila
4	00011010000	M Babu
5	00011010000	R Dhar
6	00011010000	C Jerla
7	00011010000	V Kavil
8	00011010000	L Liju
9	00011010001	S Malu
10	00011010001	A Nand
11	00011010001	N B Na
12	00011010001	B Nave
13	00011010001	Pon sh
14	00011010001	R V Ra
15	00011010001	S Sant
16	00011010001	T sarar
17	00011010001	Thana
18	960119114002	ASHINI
19	960119114003	HINOL
20	960119114004	DINESI
21	960119114005	JENISI
22	960119114006	KARTI
23	960119114007	KAVIY
24	960119114009	MIRI P
25	960119114010	MUJISI
26	960119114011	MUTHI
27	960119114012	NAGA

28	960119114013	HAVFI
29	960119114014	HITHI
30	960119114015	PAI AN
31	960119114016	SAFOE
32	960119114017	SAITHI
33	960119114019	SIVA AI
34	960119114020	SIVA S/
35	960119114022	SUMI
36	960119114023	THANI
37	960119114024	THARI
38	960119114025	UDAYA
39	960119114026	VASAM
40	960119114027	VINCHI
41	960119114028	VIVAR
42	960119114301	ASHINI
43	960119114302	ASHOK
44	960119114304	GEORGE
45	960119114305	MUTHI
46	960119103001	CHITRA
47	960119103002	KARTHI
48	960119103003	LAKSHM
49	960119103004	SUBINI
50	960119103005	UMA R
51	960119104001	ADIRAI
52	960119104002	AJAY A
53	960119104003	ANTON
54	960119104004	ASIA JI
55	960119104005	AVINI
56	960119104006	BAI A S
57	960119104008	ISHWAR
58	960119104009	KANAK
59	960119104010	KAVIN
60	960119104011	LIPION
61	960119104012	MARIAI
62	960119104013	PRATHI
63	960119104014	RANISH
64	960119104015	RONALI
65	960119104016	NEEVA P
66	960119104017	SIVA RA
67	960119104018	ROWMI

This report includes images and a copy of the attendance sheet for your convenience.

Thank you,

PRINCIPAL
ANNAI VAILANKANNI COLLEGE OF ENGINEERING
POTTALKULAM
CHAGAPPURAM - 629 401
CHENNAI DISTRICT

Mr. R. Robert, M.E.(Ph.D),
Head,
Training and Placement Cell,
Annai Vailankanni College of Engineering.

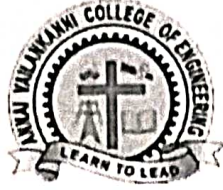

ANNAI VAILANKANNI

College of Engineering

REPORT

on
Career Guidance Program

On

28/03/2023

Training and Placement Cell

Report on Career Guidance Program On 28/03/2023

Training and Placement Cell organized a Career Guidance Program on 28th March 2023 at Annai Vailankanni College of Engineering in association with the Knowit Professional Learning App. Training and Placement Cell is always motivating the students to upskill their careers.

The main purpose of the program is to create awareness about the Skills required for the top Multinational Companies in young minds. Er, Nazeeb Nazar, Director of Knowit India Private Limited is the resource person for this program. He elaborated on the opportunities and details of the Job openings in MNCs. Totally 67 final-year students participated from various departments.



ANNAI VAILANKANNI COLLEGE OF ENGINEERING
Azhagappapuram Post – 629 401, K.K. Dist, Tamil Nadu

CAREER GUIDANCE PROGRAM

PROGRAM SCHEDULE

March 28, 2023

10.00 am	Prayer Song	:	College Choir
10.10 am	Welcome Address	:	Mr. R. Robert TPO, AVCE
10.15 am	Presidential Address	:	Dr. N. Abilash Principal I/C, AVCE.
10.30 am	Chief Guest Address	:	Er Nazeeb Nazar, Director Knowit India Private Limited
10.55 am	Vote of thanks	:	Mr. R. Yyayala Vishnu IV Mech.
11.00 am	National Anthem	:	College choir

PRINCIPAL
ANNAI VAILANKANNI COLLEGE OF ENGINEERING
POTTAL KULAM
AZHAGAPPAPURAM - 629 401
KANYAKUMARI DIST.



Annai Vailankanni College of Engineering

AVK Nagar, Pottalkulam, Kanyakumari District.
Recognized under section 2(f) of UGC Act, 1956.
Approved by AICTE, New Delhi & Affiliated to Anna University, Chennai.

Career Guidance Program

 **Knowit**
Professional Learning App

Er. Nazeeb Nazar neboosh level 6
Director
Knowit India Pvt Limited

Training and Placement Cell

Date: 28th Mar 2023

**Venue: BOSCH Training Room,
Administrative Block**

PRINCIPAL
ANNAI VAILANKANNI COLLEGE OF ENGINEERING
POTTALKULAM
AZHAGAPPAPURAM, ERODE
KANYAKUMARI DISTRICT

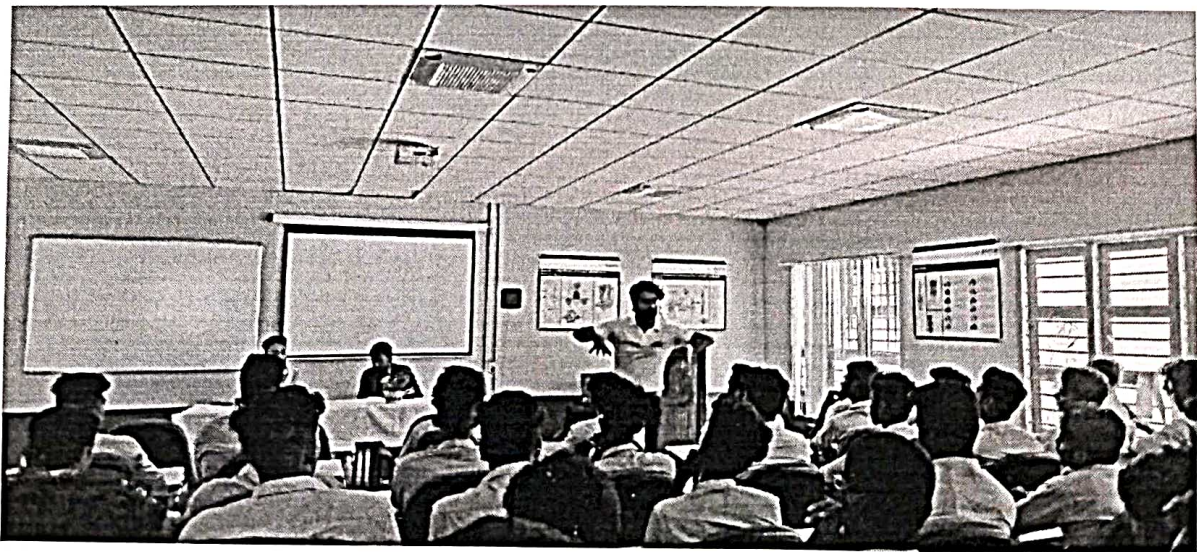

Agel
PRINCIPAL
ANNAI VAILANKANNI COLLEGE OF ENGINEERING
POTTALKULAM
AZHAGAPPALLE P.O. 629 301
KANTARAGIRI DIST.

S.No	Register Number	Name
1	96011910600	S Aarth
2	96011910600	M Akash
3	96011910600	N Akila
4	96011910600	M Babi
5	96011910600	R Dhar
6	96011910600	C Jeris
7	96011910600	V Kavitha
8	96011910600	L Liju
9	96011910601	S Maba
10	96011910601	A Nanc
11	96011910601	N S Na
12	96011910601	S Nave
13	96011910601	Pon sh
14	96011910601	R V Ra
15	96011910601	G Sant
16	96011910601	T sarar
17	96011910601	Thana
18	960119114002	ASHISI
19	960119114003	BINOL
20	960119114004	DINESI
21	960119114005	JENISH
22	960119114006	KARTH
23	960119114007	KAVIY
24	960119114009	MIRLI
25	960119114010	MUJISI
26	960119114011	MUTHI
27	960119114012	NAGA

28	960119114013	NAVEE
29	960119114014	NITHEI
30	960119114015	PALAN
31	960119114016	SANGE
32	960119114017	SATHIS
33	960119114019	SIVA AI
34	960119114020	SIVA S/
35	960119114022	SUMITI
36	960119114023	THIANL
37	960119114024	THIARN
38	960119114025	UDAYA
39	960119114026	VASAN
40	960119114027	VINOTI
41	960119114028	YUVAR
42	960119114301	ABINES
43	960119114302	ASHOK
44	960119114304	GEORG
45	960119114305	MUTHI
46	960119103001	CHITRA
47	960119103002	KARTHI
48	960119103003	LAKSHM
49	960119103004	SUBINR
50	960119103005	UMA R
51	960119104001	ABIRAJ
52	960119104002	AJAY .A
53	960119104003	ANTON
54	960119104004	ASIA JI
55	960119104005	AVINES
56	960119104006	BALA SI
57	960119104008	ISHWAR
58	960119104009	KANAK
59	960119104010	KAVIN
60	960119104011	LIPTO S
61	960119104012	MARIAI
62	960119104013	PRATHI
63	960119104014	RANISH
64	960119104015	RONALI
65	960119104016	SELVA P
66	960119104017	SIVA RA
67	960119104018	SOWMI

This report includes images and a copy of the attendance sheet for your convenience.

Thank you,

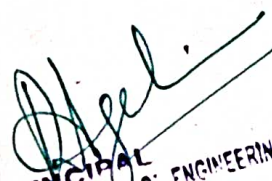
PRINCIPAL
ANNALVAILANKANNI COLLEGE OF ENGINEERING
ROTTALKULAM
AZHAGAPPANPATTAM - 629 401
KANYAKUMARI DIST.

Mr. R. Robert, M.E,(Ph.D),
Head,
Training and Placement Cell,
Annai Vailankanni College of Engineering.



ANNAI VAILANKANNI

College of Engineering

REPORT

on
TNSI Awareness Camp

On

13/02/2023

Entrepreneurship Development Cell

Report on TNSI Awareness Camp On 13/02/2023

Entrepreneurship Development Cell organized a TNSI Awareness camp on 13th February 2023 at Annai Vailankanni College of Engineering in association with EDII- TN IEDP Hub University College of Engineering Nagercoil. Entrepreneurship Development Cells (EDCs) are typically established in educational institutions to foster entrepreneurship and support aspiring entrepreneurs among students

The main purpose of the program is to create awareness about TNSI Activities in young minds. Mr . R Rajesh, Field Coordinator- EDII HUB UCEN is the resource person of this program. He elaborated on the opportunities and schemes under TNEDII



ANNAI VAILANKANNI COLLEGE OF ENGINEERING
Azhagappapuram Post – 629 401, K.K. Dist, Tamil Nadu

TNSI AWARENESS PROGRAM

PROGRAM SCHEDULE

February 13, 2023

10.00 am	Prayer Song	:	College Choir
10.10 am	Welcome Address	:	Mr.R.Robert TPO, AVCE
10.15 am	Presidential Address	:	Dr. N.Abilash Principal I/C, AVCE.
10.30 am	Chief Guest Address	:	Mr.R. Rajesh, Field Coordinator – EDII HUB UCEN.
10.55 am	Vote of thanks	:	Ms.V.Kavitha. E Leader.
11.00 am	National Anthem	:	College choir

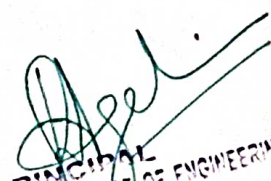
PRINCIPAL
ANNAI VAILANKANNI COLLEGE OF ENGINEERING
POTTALKULAM
AZHAGAPPAPURAM - 629 401
KANTHAKULAM DIST.



Annai Vailankanni College of Engineering

AVK Nagar, Pottalkulam, Kanyakumari District.
Recognized under section 2(f) of UGC Act, 1956.
Approved by AICTE, New Delhi & Affiliated to Anna University, Chennai.

ENTREPRENEURSHIP DEVELOPMENT CELL

Proudly Presents
TNSI Awareness Camp



Resource Person :

Mr. R. Rajesh

Field Coordinator-EDII HUB

University College of Engineering

Organized by

Prof R. Robert , EDC Coordinator



Date: 13-02-2023

📍 Venue: BOSCH Training Room

www.avce.edu.in



PRINCIPAL
ANNAI VAILANKANNI COLLEGE OF ENGINEERING
POTTALKULAM
AZHAGAPPAPURAM, S200011
KANYAKUMARI DIST.

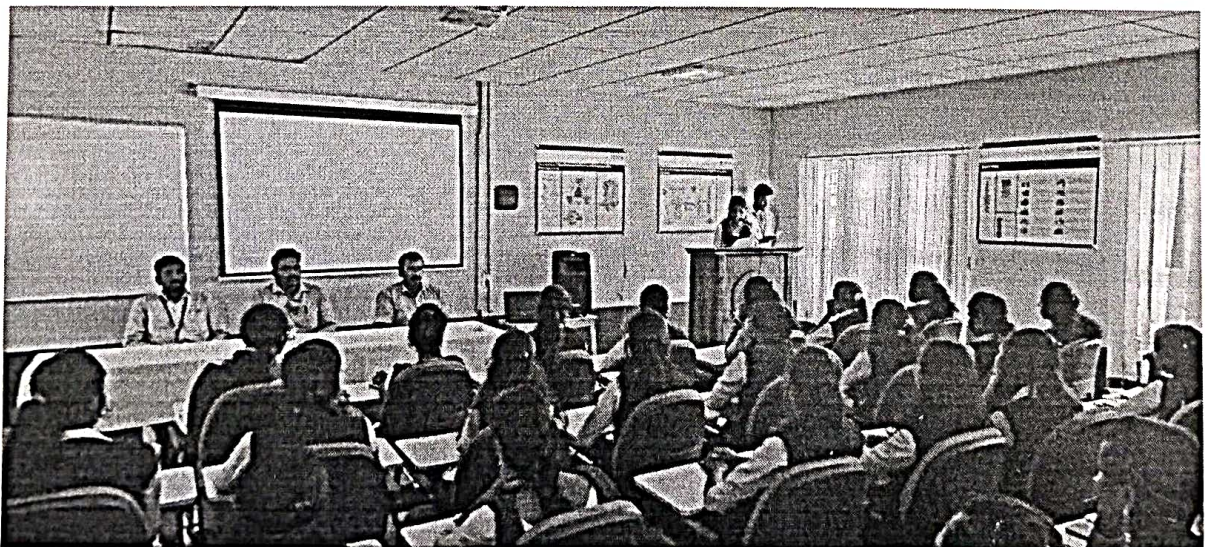

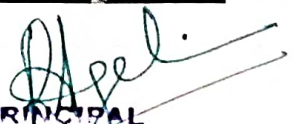
PRINCIPAL
ANNAI VAILANKANNI COLLEGE OF ENGINEERING
POTTALKULAM
AZHAGAOPAPURAM - 629 401
KANTAKUMARI DIST.

S.No	Register Number	Name
1	96011910600	S Aarth
2	96011910600	M Akash
3	96011910600	N Akila
4	96011910600	M Babu
5	96011910600	R Dhar
6	96011910600	C Jeris
7	96011910600	V Kavitha
8	96011910600	L Liju
9	96011910601	S Mabi
10	96011910601	A Nanc
11	96011910601	N S Na
12	96011910601	S Nave
13	96011910601	Pon sh
14	96011910601	R V Ra
15	96011910601	G Sant
16	96011910601	T sarar
17	96011910601	Thana
18	960119114002	ASHIISI
19	960119114003	BINOL
20	960119114004	DINESI
21	960119114005	JENISH
22	960119114006	KARTH
23	960119114007	KAVIY.
24	960119114009	MIRLI
25	960119114010	MUJISI
26	960119114011	MUTHI
27	960119114012	NAGA

28	960119114013	NAVEE
29	960119114014	NITHEI
30	960119114015	PALAN
31	960119114016	SANGE
32	960119114017	SATHIS
33	960119114019	SIVA AI
34	960119114020	SIVA S/
35	960119114022	SUMITI
36	960119114023	THIANL
37	960119114024	THARN
38	960119114025	UDAYA
39	960119114026	VASAN
40	960119114027	VINOTI
41	960119114028	YUVAR
42	960119114301	ABINES
43	960119114302	ASHOK
44	960119114304	GEORG
45	960119114305	MUTHI
46	960119103001	CHITRA
47	960119103002	KARTHIN
48	960119103003	LAKSHM
49	960119103004	SUBINR/
50	960119103005	UMA R
51	960119104001	ABIRAJ
52	960119104002	AJAY A
53	960119104003	ANTON
54	960119104004	ASIAJI
55	960119104005	AVINES
56	960119104006	BALA SI
57	960119104008	ISHWAR
58	960119104009	KANAK
59	960119104010	KAVIN .
60	960119104011	LIPTO S
61	960119104012	MARIAI
62	960119104013	PRATHE
63	960119104014	RANISH
64	960119104015	RONALI
65	960119104016	SELVA P
66	960119104017	SIVA RA
67	960119104018	SOWMIT

This report includes images and a copy of the attendance sheet for your convenience.

Thank you,

PRINCIPAL
ANNAI VAILANKANNI COLLEGE OF ENGINEERING
POTTALKULAM
AZHAGAPPAPURAM 623 401
KANTAROM

Mr. R. Robert, M.E.(Ph.D),
Coordinator,
Entrepreneurship and Development Cell,
Annai Vailankanni College of Engineering.



ANNAI VAILANKANNI
College of Engineering

REPORT

On

Awareness Programme

On

Topic

“Becoming an Entrepreneur”

conducted on

24/08/2022

Entrepreneurship Development Cell

Report on Awareness programme on the topic “Becoming an Entrepreneur” on

24th August 2022

On 24th August 2022, Seminar was conducted on “Becoming an Entrepreneur ”at our college Training Room(MB 014). The event was organized by the Innovation and Entrepreneurship Development cell.

Er. Anto Yesuraj, CEO & Chairman of Cloud hunt Technology, presented a lecture to the final year students from various departments. He described the Role of Entrepreneurs and Innovation and presented an overview of Startups for a better understanding.



Annai Vailankanni College of Engineering

A.V.K.Nagar, Azhagappapuram Post, Kanyakumari District, Tamilnadu-629 401.

Seminar on
“Becoming an Entrepreneur”

Venue: BOSCH Training room,
Administrative Block
Date: 24/8/2022
Time: 10:45 am

Resource person:
Er. Anto Yesuraj
CEO and Chairman,
Cloudhunt Technologies

Cloudhunt Technologies
Developers

Innovation and Entrepreneurship Development Cell



StartupTN



AIC

www.avce.edu.in

Anto Yesuraj
PRINCIPAL
ANNAI VAILANKANNI COLLEGE OF ENGINEERING
POTTALKULAM
AZHAGAPPAPURAM P.O. 629 401
KANYAKUMARI DIST.

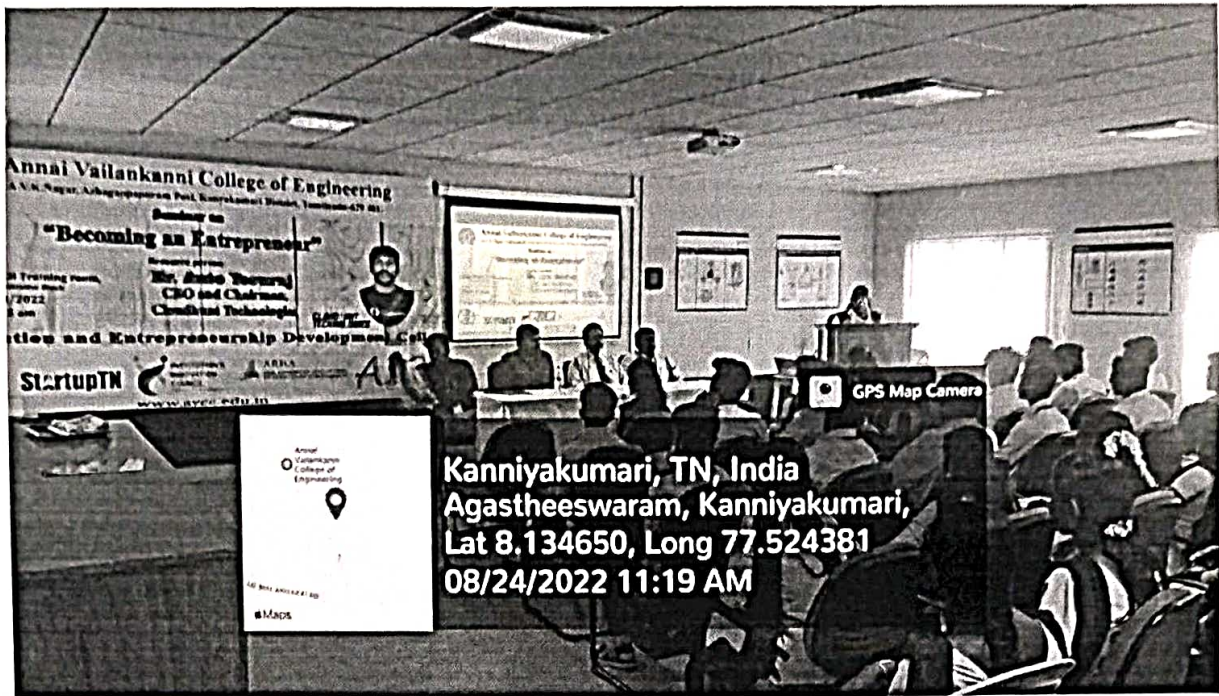

Kanniyakumari, TN, India
 Agastheeswaram, Kanniyakumari,
 Lat 8.134650, Long 77.524381
 08/24/2022 11:19 AM

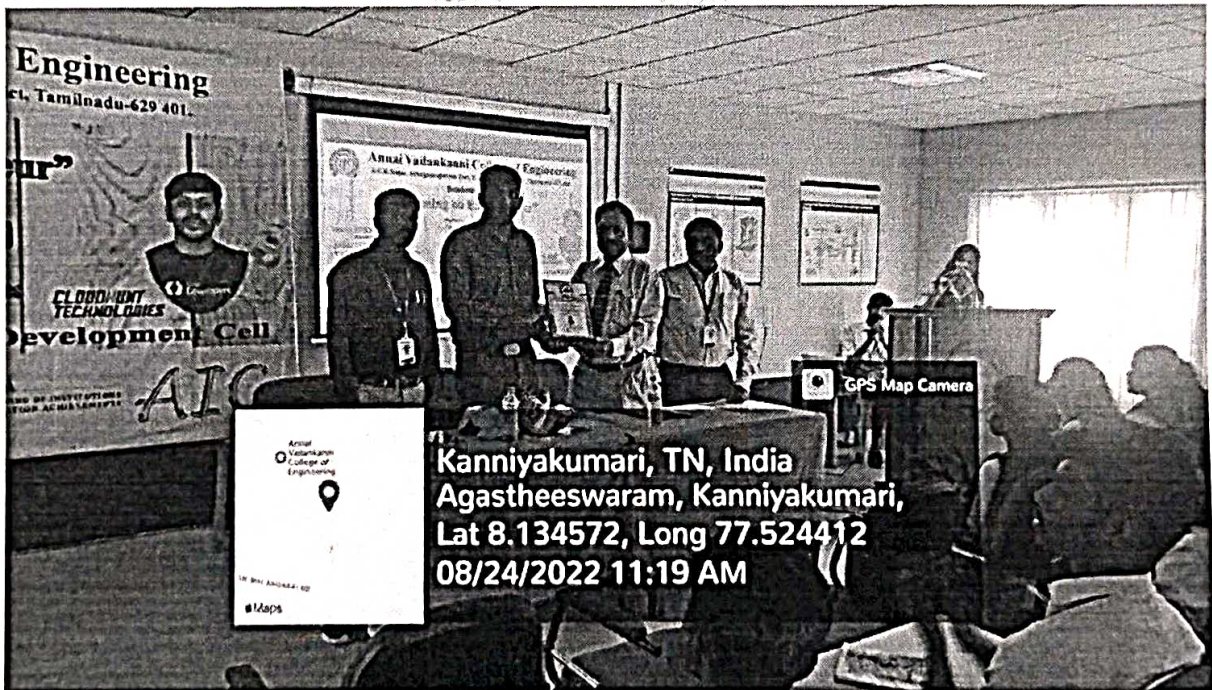

Kanniyakumari, TN, India
 Agastheeswaram, Kanniyakumari,
 Lat 8.134572, Long 77.524412
 08/24/2022 11:19 AM

Pravin
 PRVIN KAL
 ANNAI VAILANKANNI COLLEGE OF ENGINEERING
 POTALKULAM
 AZHAGAPPURAM 629 401
 KANNIYAKUMARI DIST.

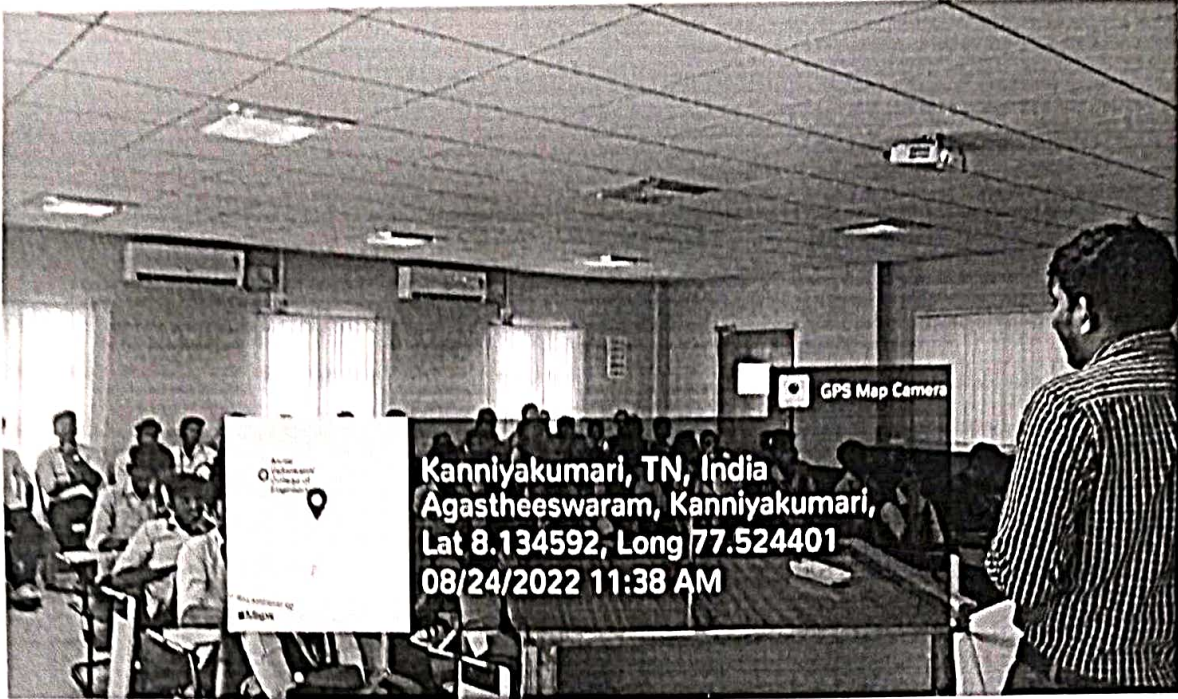

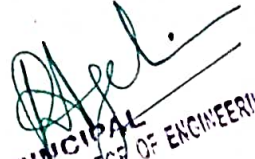

PRINCIPAL
ANNAI VAILANKANNI COLLEGE OF ENGINEERING
POTTILKULAM
AZHAGAPPAPURAM - 622 401
KANNIYAKUMARI DIST.

Following is the list of participants through Physical mode:

AnnaiVallankanni College Of Engineering Attendance Sheet

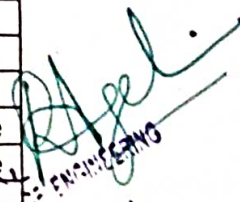
Sl.No	Name	E-mail ID	Gender
1	PRIYANKA.J	p1622918@gmail.com	Female
2	JESHIKA.S	jeshikacedrica@gmail.com	Female
3	MONISHA .M	monimanohar2002@gmail.com	Female
4	RAGUL R	raqulraj3870@gmail.com	Male
5	ASHA	Ashaanu827@gmail.com	Female
6	KAVIYA	kkaviya56989@gmail.com	Female
7	ANTO SAHAYA JAIWIN.A	Antojaiwin143@gmail.com	Male
8	ANISH. M	anishmaniharan3@gmail.com	Male
9	R.T.MONIKA	rtmonika573@gmail.com	Female
10	ASHIKA M	ashika04m@gmail.com	Female
11	RACHEL.D	rachalsy4002@gmail.com	Female
12	A.PAVITHRA	Pavithra22553@gmail.com	Female
13	SELVA THARUN R R	selvatharunrajesh@gmail.com	Male
14	SRITHAR	srihardon1234@gmail.com	Male
15	A.MARIAMMAL	maheshmuthu2728@gmail.com	Female
16	SHEKA G	shekaqnanasekar@gmail.com	Female
17	K. MUGUNTHAN MANO	muqunthanmano786@gmail.com	Male
18	A.VINOTH KUMAR	vinothkumaranthony@gmail.com	Male
19	N.MINI	minineelan1@gmail.com	Female
20	K.SHANTHINI	Santhinisanthini827@gmail.com	Female
21	ADITYAN V L	adityantvm2002@gmail.com	Male
22	R V DERVIN	dervindervin179@gmail.com	Male
23	S.PRIYANKA	Priyankastephan69@gmail.com	Female
24	A.S.PONSELVI	ponselvikannan2021@gmail.com	Female
25	SELVA PRIYA J	2selvapriya3@gmail.com	Female
26	SAM.J.DUFORT	josham2428@gmail.com	Male
27	JEROME S DOMINIC	jeromedominicv@gmail.com	Male
28	SWETHA	swethaleena83@gmail.com	Female
29	M.ANITHA	lvuani90044@gmail.com	Female
30	M. DHARSHINI	dharshiniabi576@gmail.com	Female
31	D.BHARADWAJ	wajbharad1616@gmail.com	Male
32	SHARMI.J	sharmiie2003@gmail.com	Female
33	C. SAJITHA	assaji983@mail.com	Female
34	L.K.SHAMILI	shamilisham82@gmail.com	Female
35	PAVITHRA.K	Pavithraapp368@gmail.com	Female
36	KAVASKER	keinskavasker@gmail.com	Male
37	THAMEEMALHUSSAIN	thameemalhussain55@gmail.com	Male
38	N. LIBINESH	libinesh5555@gmail.com	Male
39	M.ASUWATHI	asuwathim@gmail.com	Female
40	A. MANIMURUGESWARAN	manimirugan007@gmail.com	Male
41	M.DEEPAK	deepakbalor2493@gmail.com	Male
42	R. DINESH	dinesh051176@gmail.com	Male
43	E BEBIN RAJ	ebebin2004@gamil.com	Male
44	A.ANISHA	ajithdon979@gmail.com	Female
45	JENIFER	jenifer26112003@gmail.com	Female
46	E BEBIN RAJ	ebebin2004@gamil.com	Male
47	S.S.ABIJITH	abijithss2004@gmail.com	Male
48	ANISH.S	anishbeatz7@gmail.com	Male

 ANNA MATHURAI
 FORT ST. ENGINEERING
 AZHAGAPPANUR
 KANNI - TAMIL NADU - 629 401

49	A.CATHERIN ROFICA	catherinrofica@gmail.com	Female
50	SNOJA	snojachittu@gmail.com	Male
51	KEEBO A.L	keeboreus@gmail.com	Male
52	D.RAVEEN	draveen945@gmail.com	Male
53	NISHA NANTHINI M.S.	nishananthinims@gmail.com	Female
54	A ABISHEK	aabishek.in26@gmail.com	Male
55	HARRIS.R	harrisharr47@gmail.com	Male
56	V.MARIAPPAN	mariappan9042753975@gmail.com	Male
57	M BRITTO SOLOMON	brittosolomon2@gmail.com	Male
58	DIVYA.M	mdivya819087@gmail.com	Female
59	PAVITHRA.P	pavi36029@gmail.com	Female
60	M. RAMAKRISHNAN	ramakrishnanmurugan04@gmail.com	Male
61	M.KANNIKA	mkannika607@gmail.com	Female
62	BAVI.K	bavibavi570@gmail.com	Female
63	JOTHI	Jothijothi77497@gmail.com	Female
64	N.SNEHA	sneha280220042004@gmail.com	Female
65	S.RAJA	josephraja512@gmail.com	Male
66	L.JINISHA	jinishal186@gmail.com	Female
67	JEGATHEESH	jegatheeshjegatheesh049@gmail.com	Male
68	PRAKASH S	prakash642004s@gmail.com	Male
69	HARISH MAN.S	harishking8190@gmail.com	Male
70	DEVI.S	sujiselvamani2002@gmail.com	Female
71	ANNIES RAVIN R	annieaa222@gmail.com	Male
72	S.SUBITHA	subikutty678@gmail.com	Female
73	I. JOHNSON JEBASEELAN	johnson.jeba603@gmail.com	Male
74	ABINESH.R	abineshabi27123@gmail.com	Male
75	KINGSHERIN	Kungsherin27@gamil.com	Male
76	SHIJO. D	Shiomass99@gmail.com	Male
77	S.ANUSHA	Sanushaanu472@gmail.com	Female
78	M.NOUFAL	noufalmaideen2801@gmail.com	Male
79	ANU DHARSHINI N	anunagarajan03@gmail.com	Female
80	JOSELIN SHIJO	Joselinshijo9360@gmail.com	Male
81	K. BAVITHIRA	Pavithrak8098@gmail.com	Female
82	DINESHKUMAR. K	dineshk24270@gmail.com	Male
83	NISHA. M	nishamurugesan999@gmail.com	Female
84	T. C. TINIS CHRISTAN JOE	Joemassjoedon@gmail.com	Male
85	S.ISHWARYA	ss.ishwarya2004@gmail.com	Female
86	BHARATH.S	vasanthaamma62@gmail.com	Male
87	ABINESH.R	abineshabi27123@gmail.com	Male
88	SALINI.I	lr9202051@gmail.com	Female
89	ANITHA M	ivuai90044@gmail.com	Female
90	NANTHINI S	nanthiniasmi@gmail.com	Female
91	KRISHNAN	krishnankrishnan2003@gmail.com	Male
92	SUBIN	subinss390@gmail.com	Male
93	M.SIVA AKASH	sivadon685@gmail.com	Male
94	VISHWAHAR	diwavishwa08@gmail.com	Male
95	B JUDWIN DINO	binodino007@gmail.com	Male
96	ADWIN RAJ R	adwinking22@gmail.com	Male
97	HARISH KRISHNAN	directorc0012003@gmail.com	Male
98	JENITH J	jjenith434@gmail.com	Male
99	JINO A	jinoaj2004@gmail.com	Male

ANNA VAILANKANNI COLLEGE OF ENGINEERING
 POTTALKILAM
 AZHAGAPPURAM - 629 301
 KANTAKUMARI BIRT

100	MICHAEL SUJIN Z	miandhin52@gmail.com	Male
101	MITHINI RENOBOTH SALAL	salalrnthi@gmail.com	Male
102	SUBITHA A	subitha545@gmail.com	Female
103	THANAMSEELAN G	sheslansheslar915@gmail.com	Male
104	VIJAY PRASAS VV	vijayprasad512994@gmail.com	Male
105	AASHA	ashadhas394@gmail.com	Female
106	BELSI MARY S	blessmary332@gmail.com	Female
107	J JEBIN	mrc097192@gmail.com	Male
108	J SUBISHA	subishajayakumar33@gmail.com	Female
109	S MITHUNIA	mithunamithuna512@gmail.com	Female
110	LIJU L	liju.liju2092@gmail.com	Male
111	AKALYA M	akalyaaycs@gmail.com	Female
112	DHANESH	dhaneshcs2018@gmail.com	Male
113	MABLE VIMALA S	mables149392@gmail.com	Female
114	AKILAN	akilancs2019@gmail.com	Male
115	JERISHA G	jerishac2001@gmail.com	Female
116	SARANYA T	saranyathangarasindran@gmail.com	Female
117	NANTHINI NS	nanthini2001ns@gmail.com	Female
118	HAVEEN KUMAR S	navssn20062002@gmail.com	Male
119	BABISHA M	babishamurugan@gmail.com	Female
120	R. THANA REKA	thanareka18@gmail.com	Female
121	V. KAVITHA	Vskavitha311@gmail.com	Female
122	A. NANTHINI	ananthini143@gmail.com	Female
123	PONSEKAR, C	ponsskar002@gmail.com	Male
124	BANTHOSH G	santhoshiyappan456@gmail.com	Male

I hereby submit the report for your kind perusal.

Thank you,

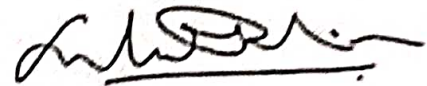

Prof. Lalu Gladson Robin,

Coordinator,

Entrepreneurship Development Cell,

Annai Vailankanni College of Engineering.

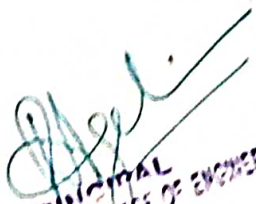

PRINCIPAL
ANNAI VAILANKANNI COLLEGE OF ENGINEERING
KOTTAIKULAM
AZHAKKOTTAIKULAM - 629 401
KANNIYAKUMARI DIST.